



# ASX Announcement

7 March 2024

## Standalone Mt Edwards Project Scoping Study Highlights Nickel Potential

### Highlights

- Compelling case for a standalone concentrator delivers:
  - Low operating costs
  - Higher payabilities
  - Demonstrates the benefits of control of our own integrated mining and milling process.
- Widgie's Resource base able to supply steady state sustainable production profile:
  - Production rate of ~800,000tpa
  - Overall 77% of material exploited in high confidence Indicated Resource category
  - 7 further Resources available to be exploited not contemplated by this Study
- Scoping Study assesses an 800ktpa standalone nickel concentrator producing 103,000tpa @ 10.1% Ni concentrate for 10,380t of contained nickel per annum
- Opportunities to consider downstream processing to improve viability now able to be considered

### **Widgie Nickel's Managing Director and CEO, Mr Steve Norregaard, commented:**

*"Nickel has only recently been added to the governments list of critical metals, which importantly opens up new avenues for the company to deliver this Project not previously available. This Study demonstrates the strategic value and uniqueness of Widgie's Nickel Resource base to the entire country and WA. It is our ability, as demonstrated by this study, to support a long life mining and processing operation that sets Widgie apart from our peers."*

*"This Scoping Study demonstrates that we have a robust nickel Project that should be progressed to the Pre-Feasibility Study stage. The fact that we have seven additional mineral resources that have not yet been examined as part of this process provides underlying confidence in the long-term nature of the standalone Project."*

*"Of course, we are cognisant that the nickel price has been quite volatile over the last year, starting at well over US\$30k/t and now sitting around US\$17.5k/t. As quickly as it has come off, we have confidence that the fundamentals are there to support the price rebounding over the future years. We are building a Project for the future, not necessarily one to be immediately developed today."*

*"This is a very significant step forward for the company."*

## Mt Edwards Nickel Project Scoping Study

Widgie Nickel Ltd (ASX: **WIN**) (“**Widgie**” or “**the Company**”) is pleased to announce the results of the Scoping Study for its 100% owned Mt Edwards Nickel Project.

### Cautionary Statement

*The Scoping Study referred to in this announcement has been undertaken for the purposes of demonstrating the business case to support a standalone integrated nickel mine and concentrator at the Mt Edwards Nickel Project. It is a preliminary technical and economic study of the potential viability of the Mt Edwards Nickel Project. It is based on low level technical and economic assessments that are not sufficient to support the estimation of ore reserves. A level of accuracy of +/-40% is applicable in accordance with Scoping level accuracy. Further exploration and evaluation work and appropriate studies are required before Widgie will be in a position to estimate any ore reserves or to provide any assurance of an economic development case.*

*The Scoping Study is based on the material assumptions outlined below. These include assumptions about the availability of funding. While Widgie considers all of the material assumptions to be based on reasonable grounds, there is no certainty that they will prove to be correct or that the range of outcomes indicated by the Scoping Study will be achieved.*

*To achieve the range of outcomes indicated in the Scoping Study, funding in the order of \$270 million will likely be required. Investors should note that there is no certainty that Widgie will be able to raise this sum of funding when needed. It is possible or likely (as the case may be) that the required funding may only be available on terms that may be dilutive to or otherwise affect the value of Widgie’s existing shares.*

*It is also possible that Widgie could pursue other ‘value realisation’ strategies such as a sale, partial sale, or joint venture of the Project. If it does, this could materially reduce Widgie’s proportionate ownership of the Project.*

*Given the uncertainties involved, investors should not make any investment decisions based solely on the results of this Scoping Study.*

### Executive Summary

- Scoping Study assesses the mining and processing of 5.05Mt of ore grading 1.56% Ni over an initial six (6) year mine production life (the “Production Target”)
- 800ktpa standalone nickel concentrator produces 103,000tpa @ 10.1% Ni concentrate for 10,380t of contained nickel per annum
- Scoping Study undertaken at a base case assumed US\$24,000/t nickel, the approximate midpoint of the nickel price during 2023 and in line with other recent ASX peer studies
- Scoping Study based only on the mining of Widgie Townsite (WTS), Gillett/Widgie 3 (GW3), Armstrong (ANM) and 132N with seven (7) remaining deposits with upgrade potential that can be included into subsequent studies
- Scoping Study provides sufficient confidence to move to a Pre-Feasibility Study for the Mt Edwards Nickel Project

- Studies examining opportunities to improve viability by considering downstream options to be pursued.

The Mt Edwards Nickel Project is located near Widgiemooltha in the Eastern Goldfields region of Western Australia, approximately 63km south of Coolgardie and 30km south-west of Kambalda. Access to the Project area is via a direct turn off from the Coolgardie-Esperance Highway north of Widgiemooltha and is accessible in all weather conditions.

The Widgiemooltha region is a mining district rich in history with activity commencing in the 1890's when gold was first discovered. Nickel exploration commenced in the region during the 1960's after nickel was discovered in Kambalda that resulted in the discovery of several significant nickel sulphide deposits and ultimately mining commenced in the region in the early 1970's.

Widgie holds a 100% interest in the nickel rights across the Mt Edwards lease tenement package, which total some 240km<sup>2</sup>. 12 nickel sulphide deposits have been identified, with the current estimated Mineral Resources base of 13.16Mt grading 1.45% nickel for 190,300 tonnes of nickel metal (all Mineral Resources are quoted at 1% Ni cut-off other than for Armstong, Widgie 3, Widgie Townsite and Gillett which are quoted at 0.7% Ni cut-off). The tenements host nickel, lithium and gold Mineral Resources with rights varying depending on the tenement grouping.

The mining plan for this Scoping Level Study evaluates Widgie Townsite, Gillett, Widgie 3, Armstrong and 132N deposits that contain Mineral Resources of 7.79Mt at 1.45% Ni for 113.1kt of contained nickel.

The proposed operation consists for four (4) underground mines, an 800ktpa nickel concentrator, a 250 room accommodation village, a 15.5km 33kV/11kV overhead HV powerline, site offices/workshops, a central administration office complex and a core yard facility. The operations will mine nickel ore that will be carted to a centrally located nickel concentrator to produce a nickel concentrate.

The underground mines were each designed with a figure 8 style decline access for efficient mining and services installation. The mine designs utilise relatively small cross section haulage declines with dimensions of (5.2mH x 5.0mW) suitable for 40t payload ejector trucks. This machinery type is important for the given amount of waste and cemented rock backfill required in the mining schedule. These smaller declines allow for faster development rates, less blast holes, less ground support and less waste rock removal relative to the standard decline dimensions (5.8mH x 5.5mW). Mine planning has incorporated full main infrastructure engineering designs for HV power, ventilation, pumping, water supply and secondary means of egress for each mine. The main mining method for the four (4) underground mines can be best described as a bottom up panel long hole stoping method with waste (**WRF**) or cemented rock fill (**CRF**).

The Production Target assessment process has used the current Mineral Resource models and applied a 0.9% Ni grade cut-off during the Mine Stope Optimiser (**MSO**) stope selection process. This has provided raw mining volume estimate for each Resource. Further mining dilution and recovery factors have then been applied along with practical economics for each individual stoping panel. This process has resulted in a total Production Target of 5.05Mt grading 1.56% Ni containing 78.8kt of nickel metal for the Project. The Production Target comprises 77% of Resources classified as Measured/Indicated and 23% as Inferred.

The focus of the first two (2) years of the mine plan calls for the development of the Widgie Townsite (**WTS**), and Gillett/ Widgie 3 (**GW3**) underground mines. This pre-production stage of the operational plan incorporates the construction of a HV powerline, concrete batch plant, main administration

complex, nickel concentrator and accommodation village. Completion of the accommodation village is scheduled for month 4, energising of the main HV powerline month 5 and commissioning of the processing plant month 16. The Armstrong underground mine is scheduled for commencement at the start of year 5 with commencement of the 132N underground mine scheduled for the start of year 5 month 10.

Monthly performance for the Project after ramp-up averages 68kt of ore produced and 450m of jumbo development completed. In total for the four (4) underground mines, there is 15.2km of main haulage way development and 48.7km of total mine development to be completed. The number of jumbo development crews peaks at 4 in year 3 averaging 2.1 jumbo development crews over the life of the operations. During the Project, there is 2.4Mt of WRF and 0.67Mt of CRF required to be placed in stope voids. In total, there is 19.1Mtkm of trucking material movement. The average load and haul fleet size consists of 6 loaders and 6 trucks. The mining workforce including mobile maintenance during the Project averages 145 persons with a peak of 193 persons in year 6.

The proposed processing flowsheet consists of a 220t/h 3 stage mobile crushing circuit producing crushed material to minus 10mm. The crushed material is conveyed to a fine ore bin of 14hr live capacity (1,400t) before being fed into a 100t/h ball mill circuit. Material is ground to P<sub>80</sub> 53 micron in the milling circuit then proceeds into the first conditioning tank with chemicals added prior to entering the rougher and scavenger flotation cells. Tailings are then transferred to a tailings thickener with a thickened tails stream of 50% solid pulp density subsequently pumped to the tailings storage facility. Sulphide minerals recovered from the rougher and scavenger float cells are fed into a second conditioning tank prior to entering the cleaner cells to improve the nickel grade and quality of the concentrate. Cleaned concentrate collected from the cleaner float cells is then pumped to the concentrate thickener before dewatering and washing within a pressure filter. The filter cake of 6% moisture is discharged for storage in a shed ready for transport and shipping.

When in full production, the maximum milling rate applied is 70kt per month with average monthly concentrate production for the Project being 8.6kt. The targeted concentrate grade for the processing plant is 10.1% nickel with an average nickel recovery of 79%. The concentrate product will contain payable quantities of nickel, cobalt and palladium. After being stockpiled on site the concentrate will be transported to the Esperance Port for overseas export upon sufficient product being available ready for shipment.

The operations will utilise a fully Fly in/Fly out (**FIFO**) workforce with accommodation provided by the 250 room onsite accommodation village. Transport to and from the Project has been costed utilising three (3) charter flights per week flying from Perth to the Kambalda airport. Full manning levels for the operation averages 240 over the life of the Project with a peak of 290 in year 5. Average non mining workers at full production is 77 comprising 41 people allocated for the processing plant, the balance in administration or support services. Average personnel onsite for the Project is 159 persons. During the village construction period, an offsite accommodation facility in Kambalda will be utilised.

The Project operations are scheduled to reach full commercial production in month 16 with the estimated pre-production capital cost being AUD\$257M. When in full production the average monthly operating costs for the operation is AUD\$10M. During this period, capital costs per month average AUD\$2.6M, fluctuating between AUD\$409k up to AUD\$8.6M. The estimated total unit operating costs over the life of the Project is AUD\$161/t milled with total capital costs of AUD\$433M.

The total unit operating costs were calculated as AUD\$97 per ore tonne for mining, AUD\$34 per tonne processed for milling (including power) with other ancillary costs being AUD\$22/t. Annual power costs at commercial production average AUD\$15.5M.

The Project is estimated to generate AUD\$402M free cash over a 94 month period with a maximum negative cashflow of AUD\$269.2M in month 16 at a US\$24,000/t Ni price applying an exchange rate 0.65 AUD/USD. The estimated pre-mine gate unit operating nickel production cost is US\$3.67/lb. Total past mine gate costs have been estimated at AUD\$230.2M, which includes all third-party royalties and AUD\$43.5M Western Australian State royalties. The calculated NPV at an 8% discount rate for the Project is AUD\$197.4M and internal rate of return of 22.9%.

From the current defined Production Target of 5.05Mt @ 1.56% Ni, full operation mine production can be achieved for 6 years. There are seven (7) additional defined Mineral Resources (5.37Mt @ 1.44% Ni) located at the Mt Edwards Nickel Project providing substantial upside and high probability of mine life extending beyond the Scoping Study projected life.

These additional Mineral Resources will be assessed and ultimately exploited, if viable, to provide an increase to the production cashflow and mine life of the Project.

**Table 1 - Mt Edwards Scoping Study Key Outcomes**

PARAMETER	UNIT	PROJECT TOTAL
<b>KEY ASSUMPTIONS</b>		
Nickel Price	US\$/tonne	24,000
Diesel Price	US\$/litre	1.20
Exchange Rate	AUD:USD	0.65
Discount Rate	%	8.0
Concentrator Nickel Recovery (Ni)	%	79.0
Offtake Nickel Payability	%	80.0
Unit Power Cost	AUD\$/kWhr	0.20
Total Concentrate Transport Costs	AUD\$/wmt	110.97
<b>PRODUCTION TARGET</b>		
Life of Mine	Months	94
Total Ore Mined	Tonnes	5,047,555
Total Jumbo Development	metres	48,734
Total Truck Material Movement	tkm	19,171,620
Total Ore Milled	dmt	5,047,555
Average Feed Grade	% Ni	1.56
Concentrate Produced	dmt	616,668
Concentrate Grade	% Ni	10.1
Contained Nickel	Tonnes	62,283
<b>FINANCIALS</b>		
Total Operating Costs	AUD\$	812,719,828
Total Capital Costs	AUD\$	433,227,055

Pre Production Capex	AUD\$	257,029,982
Max Negative Cashflow (Month 16)	AUD\$	-269,209,468
Total Past Mine Gate Costs	AUD\$	230,232,929
(Con Transport, Offtake, Royalties)		
Total Net Revenue (Minus Past Mine Gate Costs)	AUD\$	1,647,956,772
Total Cumulative Cashflow (Pre Tax)	AUD\$	402,009,886
Discounted Cashflow (@ 8%) - NPV <sub>8</sub>	AUD\$	197,378,393
Internal Rate of Return	%	22.9
<b>UNIT COSTS</b>		
Unit Operating Costs (C1)	AUD\$/t milled	161.01
Unit Mining Operating Costs (Inc Power)	AUD\$/t mined	97.16
Unit Milling Operating Costs (Inc Power)	AUD\$/t milled	33.98
Unit All in Sustaining Costs	AUD\$/t milled	195.92
Unit All in Costs	AUD\$/t milled	246.84
Unit Nickel Operating Production Cost	US\$/lb in Con	3.67
(Excluded Past Mine Gate Costs)	AUD\$/t in Con	12,432
Comparative C1 Nickel Production Cost	US\$/lb Payable	5.39

## Background

Widgie Nickel commissioned this Scoping Study for the purpose of carrying out a preliminary assessment of the technical and financial viability of a standalone nickel mining and processing operation. The proposed Project is planned for construction on the Company's tenement package located in the Widgiemooltha mining district of Western Australia. The proposed Project consists of four (4) underground nickel mines, an 800ktpa nickel concentrator and a 250 room village.

This Scoping Study covers various aspects of the proposed operation including mine designs, a comprehensive mine construction plan, metallurgical test work and subsequent process flowsheet development, HV power surface distribution designs culminating in a full cost estimate with recently sourced market offtake terms leading to a detailed financial model.

## Location

The Mt Edwards Nickel Project is located immediately west of the Coolgardie-Esperance Highway, approximately 63km south of Coolgardie and 30km south-west of Kambalda (Figure 1). Access to the Project area is via direct turn off from the Coolgardie-Esperance Highway and is accessible in all weather conditions.

# Standalone Mt Edwards Project Scoping Study Highlights Nickel Potential

7 March 2024

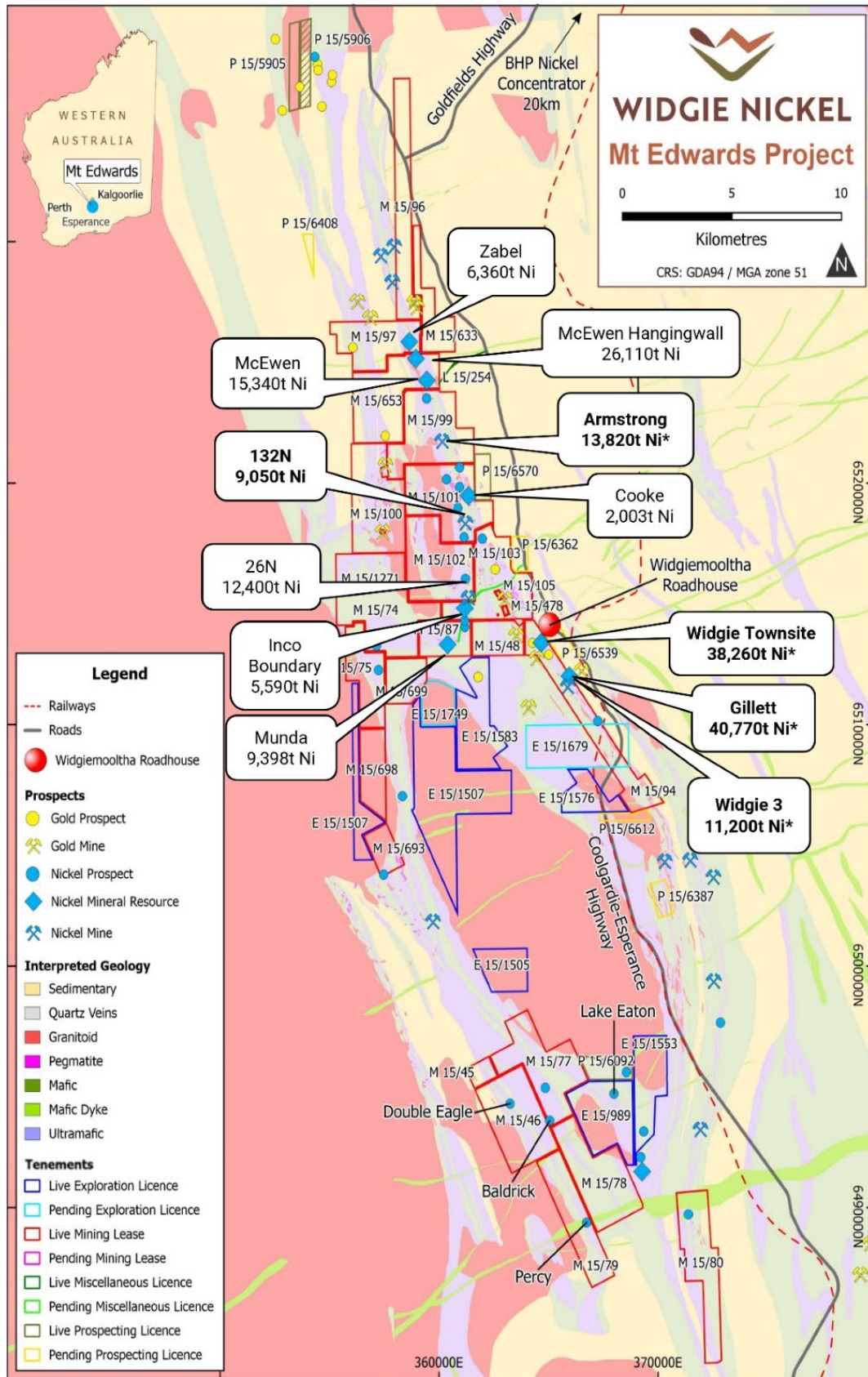

**Figure 1 - Project Location Plan**

## Geology and Nickel Mineralisation Interpretation

The Mount Edwards Nickel Project lies predominantly within the Coolgardie Domain on the western margin of the Kalgoorlie Terrane in the Norseman-Wiluna Greenstone Belt of the Archaean Yilgarn Craton, Western Australia.

The characteristic stratigraphy of the Kalgoorlie Terrane consists of a lower basalt unit overlain by komatiite, which is in turn overlain by an upper basalt unit. This mafic-ultramafic succession, referred to as the Coolgardie Group, is overlain by a unit of felsic volcanic and sedimentary rocks, the Black Flag Group that is found to the east of the Project area. The stratigraphic sequence within the Coolgardie Domain is inferred to be a continuation of the Kambalda stratigraphy.

The greenstone sequence has been subdivided into six (6) stratigraphic units. Four (4) phases of deformation have been recognised in the Widgiemooltha mining district and surrounding areas comprised of an early phase of D1 recumbent folding and thrusting followed by a transpressional regime with large scale, upright open folding (D2), sinistral, strikeslip D3 faulting (with associated en-echelon folds) and prolonged ENE to WSW regional shortening (D4).

The area also hosts significant felsic intrusive units containing lithium mineralisation throughout the Coolgardie Greenstone Domain. Figure 1 demonstrates the local geology and nickel endowment.

## Mineral Resources

Widgie's current Mineral Resource status stands at 190,300 nickel tonnes contained within 12 deposits (Table 2). In line with this Scoping Study, the Mineral Resource evaluation of each deposit is ongoing.

**Table 2 - Mt Edwards Nickel Project Mineral Resources**

Deposit	Indicated		Inferred	Total Resources			
	Tonnes (kt)	Nickel (%)	Tonnes (kt)	Nickel (%)	Tonnes (kt)	Nickel (%)	Nickel Tonnes (kt)
Widgie Townsite*	1,649	1.60	852	1.38	2,502	1.53	38.26
Widgie 3*	512	1.34	222	1.95	734	1.53	11.20
Gillett*	2,267	1.35	871	1.16	3,138	1.30	40.77
Armstrong*	949	1.45	10	1.04	959	1.44	13.82
132N	34	2.90	426	1.90	460	2.00	9.05
Munda			508	1.85	508	1.85	9.40
Cooke			154	1.30	154	1.30	2.00
Inco Boundary			464	1.20	464	1.20	5.59
McEwen			1,133	1.35	1,133	1.35	15.34
McEwen Hangingwall			1,916	1.36	1,916	1.36	26.11
Mt Edwards 26N			871	1.43	871	1.43	12.40
Zabel	272	1.94	53	2.04	325	1.96	6.36
<b>TOTAL</b>	<b>5,683</b>	<b>1.48</b>	<b>7,480</b>	<b>1.42</b>	<b>13,164</b>	<b>1.45</b>	<b>190.30</b>

Note: All Resource stated at 1% lower cut, other than Armstrong, Widgie Townsite, Widgie 3 and Gillett at 0.7% lower cut

## Mineral Resource Modelling

Detailed commentary for each Mineral Resource Estimate (MRE) that informed this Scoping Study can be found in the corresponding ASX announcements listed below:



- **Armstrong** “Armstrong Mineral Resource Update” released 13 December 2023. (ASX:WIN)
- **Gillett** “Substantial Uplift to Gillett Mineral Resource” released 9 January 2024. (ASX:WIN)
- **Widgie 3** “Widgie 3 Mineral Resource Update” released 15 January 2024. (ASX:WIN)
- **Widgie Townsite** “Widgie Townsite Nickel Mineral Resource Update” released 29 January 2024. (ASX:WIN)
- **132N** “132 Nickel Mineral Resource and Exploration Update at Mt Edwards” 6 October 2020. (ASX:NMT)

For the purpose of the economic assessment of 132N byproducts, Widgie has used the estimated grade for Pt and Pd from the November 2023 Armstrong MRE being 0.4ppm Pd and 0.2ppm Pt. This is considered appropriate as the average grade of the Pt and Pd composites assayed above 0.5% Ni returned 0.59ppm Pd and 0.20ppm Pt.

## Geotechnical Assessment

Widgie engaged MineGeoTech (**MGT**) to undertake a scoping level geotechnical study for the Widgie South and 132N Projects as part of the broader Mt Edwards Project. The Widgie South Project includes the Widgie Townsite, Gillett, Widgie 3 and the 132N deposits. MGT have previously produced a Feasibility Level Geotechnical Study for the Armstrong deposit in May 2023.

MGT undertake geotechnical studies in line with recommended Read and Stacey (2009) study parameters. This criterion is widely used in the mining industry to gauge the level of geotechnical input required for the different stages of a mining study.

### Weathering Profile

The rock mass has a very rapid weathering profile change from oxide (clays) to competent basalt. The weathering profile is deeper in the ultramafic units. All underground development is expected to be in fresh ground except for the 2 vertical raise bores developed to surface for WTS and the vertical fresh air shaft development for Gillett.

The expected depth of weathering and primary contact for each of the mines is:

- WTS varies from 45m (Basalt) to 115m (Ultramafic).
- Widgie 3 varies from 20m (Basalt) to 40m (Ultramafic).
- Gillett varies from 25m (Basalt) to 80m (Ultramafic).
- Armstrong varies from 25m (Basalt) to 60m (Ultramafic).
- 132N varies from 30m (Basalt) to 50m (Ultramafic).

### Rock Mass Quality

Rock mass classification is a method to characterise the quality of the rock mass which is then used for stability analysis and numerical modelling. Data used and parameters derived are from the geotechnical logging of core. Both the NGI Q System and Geological Strength Index (**GSI**) were assessed. Rock mass quality for Widgie Townsite, Widgie 3 and Gillett are summarised below in Table 4. The rock mass quality for Armstrong is shown in Table 5. Logged data was summarised into the previously listed geotechnical domains. The data was also combined over the 4 deposits as they are considered continuous lithological units. Typical cross sections of each deposit with the associated lithological units are shown below in figures 2, 3, 4, 5 & 6.

**Table 3 - Rock Mass Quality for WTS, GW3, 132N**

Statistic	Basalt 1			Basalt 2			Gillet Lode			Porphyry			Ultramafic		
	RQD	Q'	GSI	RQD	Q'	GSI	RQD	Q'	GSI	RQD	Q'	GSI	RQD	Q'	GSI
Nbr. of observations	1297	1297	1297	167	167	167	169	169	169	63	63	63	2035	2035	2035
Sum of weights	3345.2	3345.2	3345.2	347.2	347.2	347.2	252.9	252.9	252.9	100.1	100.1	100.1	4300.4	4300.4	4300.4
Minimum (actual)	0	0.2	17.3	87	11.4	67.8	70	2.2	51.8	0	0.5	22	0	0.1	12
Maximum (actual)	100	800	94	100	533.3	94	100	800	91.6	100	533.3	212	100	1066.7	94
10th Percentile	96	16.7	67.3	95	25	72	90	12.3	63	75	6.8	55.3	92	8.3	59.9
1st Quartile	98	24.8	72.3	99	33.3	72.3	98	16.7	67.3	90	16.5	68	98	22	68.8
Median	100	48.5	76	100	130.7	89	100	50	78.7	94	24.5	71.3	100	33.3	72.3
3rd Quartile	100	100	82.2	100	200	92	100	100	88	98	100	86	100	98	82.7
90th Percentile	100	200	91.1	100	300	92	100	384	91.6	100	165.3	90	100	300	89
Mean	97.8	110	77.6	98.7	136.2	83.8	97.5	136	77.5	88.1	67.3	75.3	96.4	101.8	74.1
Variance	70.6	33906.3	77.3	6.3	14436.3	80	31.5	46764.4	109.6	444.6	8143.8	683.9	133.7	32854.6	143.3
Std. Dev.	8.4	184.1	8.8	2.5	120.2	8.9	5.6	216.3	10.5	21.1	90.2	26.2	11.6	181.3	12

**Table 4 - Rock Mass Quality for W3 and WTS**

Statistic	W3 Lode			WTS Lode		
	RQD	Q'	GSI	RQD	Q'	GSI
Nbr. of observations	25	25	25	38	38	38
Sum of weights	30.2	30.2	30.2	51.7	51.7	51.7
Minimum (actual)	70	11.9	70	18.8	6.3	36
Maximum (actual)	100	533.3	94	100	533.3	94
10th Percentile	96	25	72	90	9.8	61
1st Quartile	97	117.3	86	97.5	12.5	70.3
Median	100	133.3	90	100	30	72
3rd Quartile	100	200	92	100	75	72.3
90th Percentile	100	300	92	100	533.3	94
Mean	98.2	151.9	86.7	96.8	103.4	73.4
Variance	16.3	9025.3	61	91.9	26840	123
Std. Dev.	4	95	7.8	9.6	163.8	11.1

**Table 5 - Rock Mass Quality for Armstrong**

Statistic	HWUM			LODE			UBAS			FWUM			LBAS		
	RQD	Q'	GSI	RQD	Q'	GSI	RQD	Q'	GSI	RQD	Q'	GSI	RQD	Q'	GSI
Nbr. of observations	466	466	466	40	40	40	170	170	170	72	72	72	153	153	153
Sum of weights	1227.1	1227.1	1227.1	111.0	111.0	111.0	447.7	447.7	447.7	204.1	204.1	204.1	418.1	418.1	418.1
Minimum (actual)	0	0.2	18	0	0.5	26	0	0.9	8	0	0.7	26	0	0.1	10
Maximum (actual)	100	600.0	92	100	150	89	100	800.0	92	100	400.0	92	100	800	94
10th Percentile	49	2.7	51	48	2.2	49	69	7.8	58	64	4.4	53	80	7.2	59
1st Quartile	77	5.2	60	67	6.1	60	89	14.8	63	85	10.6	66	95	18.9	71
Median	93	12.4	70	95	16.3	69	97	22.9	74	97	23.8	72	100	100.0	89
3rd Quartile	98	25.0	75	98	49.2	81	100	50.0	76	100	50.0	82	100	133.3	89
90th Percentile	100	65.6	82	100	97.3	88	100	100.0	89	100	133.3	92	100	300	92
Mean	83.7	27.8	67.0	81.1	35.5	69.2	88.3	51.4	70.8	86.25	47.6	71.0	93.1	138.2	80.1
Variance	435.9	2927.3	173.4	503.4	1652.4	214.0	480.1	9600.4	196.5	564.15	4790.0	243.0	289.1	33990.9	257.7
Std. Dev.	20.9	54.1	13.2	22.4	40.6	14.6	21.9	98.0	14.0	23.75	69.2	15.6	17.0	184.4	16.1

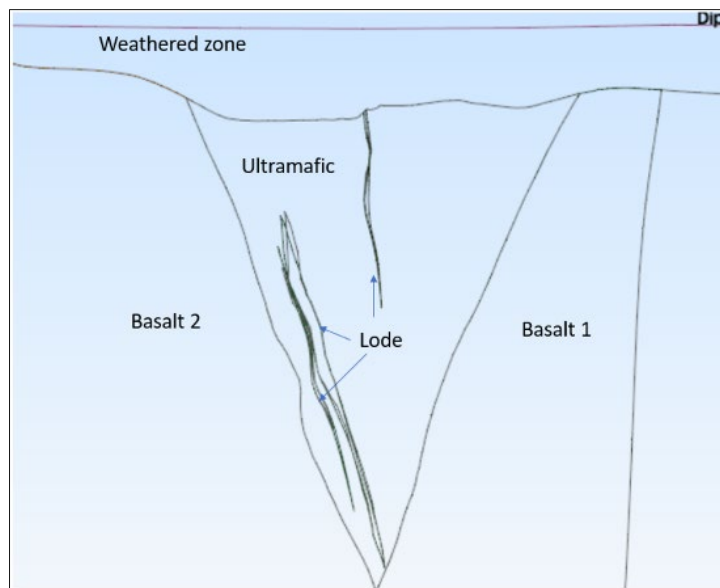

**Figure 2 -Widgie Townsite**

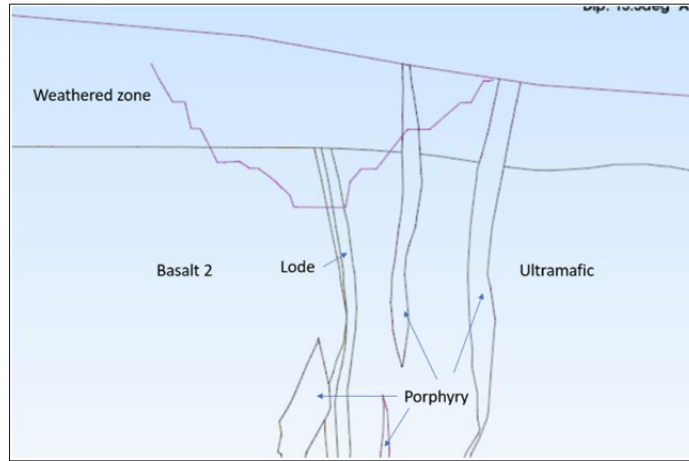

**Figure 3 -Widgie 3**

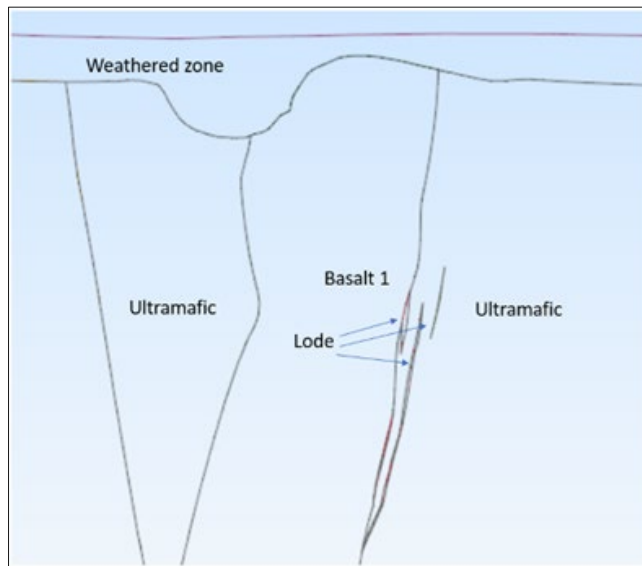

**Figure 4 - Gillett**

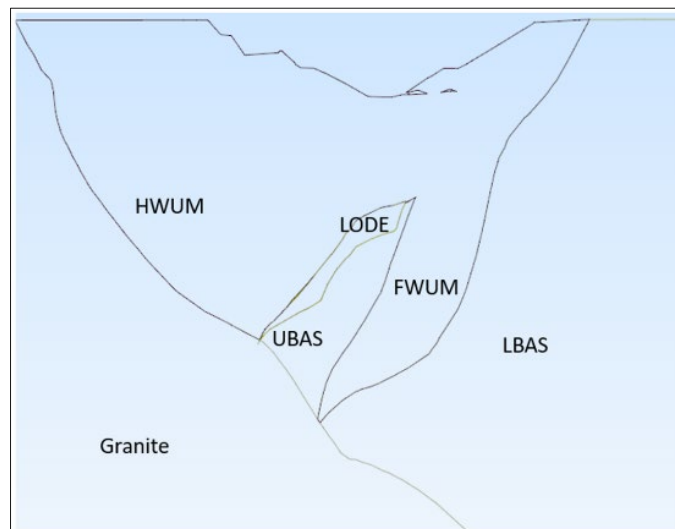

**Figure 5 - Armstrong**

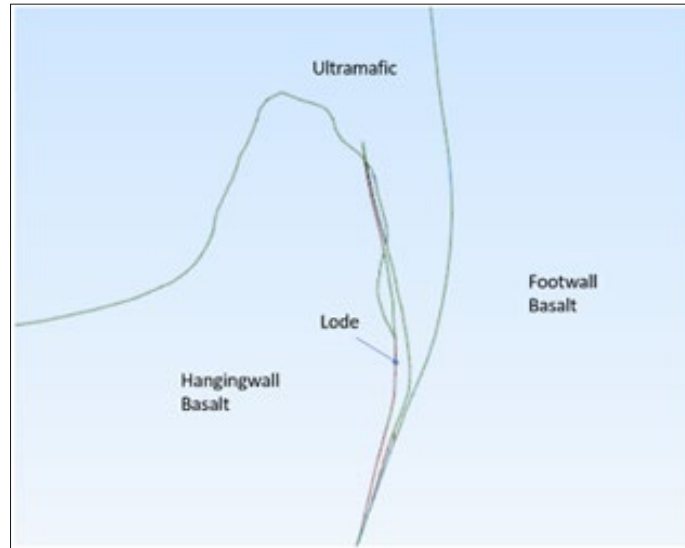

Figure 6 -132N

All domains were categorised as good to very good based on the 25th percentile ‘Q’ values.

Coinciding with RQD measurements the various deposits and host rock domains have had uniaxial compressive strength testing carried out on drill core. Testing by single stage triaxial tests (**TRX**) and Indirect/Brazilian test (**BTR**) have resulted in Intact strength measurements and Hoek Brown Constants being determined to characterise the rock mass as detailed in Table 6.

Table 6 - Rock Properties

Domain	No. of TRX	No. of BTS	UCS	mi
<b>Widgie Townsite</b>				
Footwall Ultramafic	7 (of 16)	5	45	4
Hangingwall Ultramafic	14 (of 15)	5	35	8
Basalt 2	5 (of 15)	5	160	10
LODE	7 (of 16)	5	100	10
<b>Gillett</b>				
Ultramafics	11 (of 12)	5	65	15
Lode	5 (of 6)	2	210	14
Basalt 1	9	2	290	18
<b>Widgie 3</b>				
Ultramafics	9 (of 13)	5	55	8
Lode	8 (of 9)	5	60	6
Basalt 2	14 (of 18)	7	160	8
Porphyry	6 (of 11)	4	275	18

Armstrong				
<b>HWUM</b>	5 (of 9)	2 (of 3)	49	5.9
<b>FWUM</b>	6	2	135	6.8
<b>UBAS</b>	9	2	123	6.7
<b>LBAS</b>	6	3	187	9.7
<b>LODE</b>	15	2	135	4.8

At time of writing, 132N results remain outstanding but results are anticipated to be similar to the Widgie South deposits based on visual observation.

## In-situ Stress and Seismicity

Experience with other sites in the area suggest the stress magnitudes will be in the region of 2-2.5 times the vertical stress. Due to the shallow nature of the deposits, stress is not expected to be an issue and stress measurements are therefore unlikely to be required except at WTS deposit where the orebody extends to a depth of approximately 500m coinciding with the lowest strength ultramafic.

## Development Ground Support Design

The ground support scheme requirements are assessed by two different options. The first is the Q-system using recent assessments from NGI 2015 and Potvin 2019. The second is kinematic assessment of the structural sets using the Rocscience software. The recommended ground support scheme follows from the above with consideration of the development round dimensions.

In addition to rock mass quality, two other factors are used for the empirical design, these are the drive dimension, i.e. span or height and the expected life of the excavation.

Based on the results of the empirical analysis, weld mesh and friction bolts on a 1.1m x 1.7m spacing (bolt x ring) can be applied to the Basalt, Porphyry and Gillett Lode domains at Widgie South and the Basalt domains at 132N. A maximum mesh height of 3.5m above the floor for these geotechnical domains and all drive sizes can be applied. Weld mesh should have a gauge of 5.6mm with 100mm x 100mm apertures.

For the Ultramafic, Widgie 3 Lode and WTS Lode domains at Widgie South and the Ultramafic and Lode domains at 132N, the empirical analysis determined that weld mesh and decoupled resin encapsulated thread bar bolts on a 1.1m x 1.7m spacing should be applied. Mesh should be brought down to grade line on both walls in all drive sizes in these domains. Weld mesh should have a gauge of 5.6mm with 100mm x 100mm apertures.

For the Armstrong report (MGT, 2023), based upon cut length of 3.4m in capital development and 2.8m in production drives, the following mesh size and bolt number recommendations have been provided in the below Table 7, Table 8, Table 9, Table 10 and Table 11 for all deposits at Widgie South, Armstrong and 132N. These estimates are based on the mesh being placed with the long axis parallel to the direction of the drive and mesh overlaps of 300mm. The bolt quantities include four spot bolts per cut for supporting the walls below the mesh when split sets are applied. For the resin bolt quantities, it is assumed that a ring of split sets is required at the overlaps infilled with five (5) resin bolts in the backs.

**Table 7 -Widgie Town Site Development Ground Support Design**

Development Profile	Domain	Cut Length (m)	Surface Support		Reinforcement		
			Type	Quantity	Spacing	Type	Quantity
5.0m x 5.0m Decline - Capital Access - Capital	Basalts	3.4	Mesh (2.4m x 3.7m)	4 Sheets	1.1m x 1.7m	2.4m Split Sets 0.9m Stubby Bolts	22 9
5.0m x 5.0m Decline - Capital Access - Capital	Ultramafics	3.4	Mesh (2.4m x 3.7m)	6 Sheets	1.1m x 1.7m	2.4m Resin Bolts 2.4m Split Sets 0.9m Stubby Bolts	31 13 13
4.5m x 4.5m Access - Operating	Basalts	3.4	Mesh (2.4m x 3.7m)	3 Sheets	1.1m x 1.7m	2.4m Split Sets 0.9m Stubby Bolts	18 7
4.5m x 4.5m Ore Drive - Operating	Ultramafics Ore Lode	3.4	Mesh (2.4m x 3.7m)	5 Sheets	1.1m x 1.7m	2.4m Resin Bolts 2.4m Split Sets 0.9m Stubby Bolts	27 11 11

**Table 8- Widgie 3 Development Ground Support Design**

Development Profile	Domain	Cut Length (m)	Surface Support		Reinforcement		
			Type	Quantity	Spacing	Type	Quantity
5.0m x 5.0m Decline - Capital Access - Capital	Basalts	3.4	Mesh (2.4m x 3.7m)	4 Sheets	1.1m x 1.7m	2.4m Split Sets 0.9m Stubby Bolts	22 9
5.0m x 5.0m Decline - Capital Access - Capital	Ultramafics	3.4	Mesh (2.4m x 3.7m)	6 Sheets	1.1m x 1.7m	2.4m Resin Bolts 2.4m Split Sets 0.9m Stubby Bolts	31 13 13
4.5m x 4.5m Access - Operating	Basalts	3.4	Mesh (2.4m x 3.7m)	3 Sheets	1.1m x 1.7m	2.4m Split Sets 0.9m Stubby Bolts	18 7
4.5m x 4.5m Ore Drive - Operating	Ultramafics Ore Lode	3.4	Mesh (2.4m x 3.7m)	5 Sheets	1.1m x 1.7m	2.4m Resin Bolts 2.4m Split Sets 0.9m Stubby Bolts	27 11 11

**Table 9 -Gillett Development Ground Support Design**

Development Profile	Domain	Cut Length (m)	Surface Support		Reinforcement		
			Type	Quantity	Spacing	Type	Quantity
5.0m x 5.0m Decline - Capital Access - Capital	Basalts	3.4	Mesh (2.4m x 3.7m)	4 Sheets	1.1m x 1.7m	2.4m Split Sets	22
						0.9m Stubby Bolts	9
5.0m x 5.0m Decline - Capital Access - Capital	Ultramafics	3.4	Mesh (2.4m x 3.7m)	6 Sheets	1.1m x 1.7m	2.4m Resin Bolts	31
						2.4m Split Sets	13
						0.9m Stubby Bolts	13
4.5m x 4.5m Access - Operating	Basalts	3.4	Mesh (2.4m x 3.7m)	3 Sheets	1.1m x 1.7m	2.4m Split Sets	18
						0.9m Stubby Bolts	7
4.5m x 4.5m Ore Drive - Operating	Ultramafics Ore Lode	3.4	Mesh (2.4m x 3.7m)	5 Sheets	1.1m x 1.4m	2.4m Split Sets	18
						0.9m Stubby Bolts	7

**Table 10 -Armstrong Development Ground Support Design**

Development Profile	Domain	Cut Length (m)	Type	Quantity	Spacing	Type	Quantity
5.0m x 5.0m Decline - Capital Access - Capital	Basalts	3.4	Mesh (2.4m x 3.7m)	4 Sheets	1.1m x 1.7m	2.4m Split Sets	22
						0.9m Stubby Bolts	9
5.0m x 5.0m Decline - Capital Access - Capital	Ultramafics	3.4	Mesh (2.4m x 3.7m)	4 Sheets	1.1m x 1.4m	2.4m Split Sets	27
						0.9m Stubby Bolts	11
4.5m x 4.5m Access - Operating	Basalts	3.4	Mesh (2.4m x 3.7m)	3 Sheets	1.1m x 1.7m	2.4m Split Sets	18
						0.9m Stubby Bolts	7
4.5m x 4.5m Ore Drive - Operating	Ultramafics Ore Lode	3.4	Mesh (2.4m x 3.7m)	5 Sheets	1.1m x 1.4m	2.4m Split Sets	18
						0.9m Stubby Bolts	7



**Table 11 – 132N Development Ground Support Design**

Development Profile	Domain	Cut Length	Surface Support		Reinforcement		
		(m)	Type	Quantity	Spacing	Type	Quantity
5.0m x 5.0m Decline - Capital Access - Capital	Basalts	3.4	Mesh (2.4m x 3.7m)	4 Sheets	1.1m x 1.7m	2.4m Split Sets 0.9m Stubby Bolts	22  9
5.0m x 5.0m Decline - Capital Access - Capital	Ultramafics	3.4	Mesh (2.4m x 3.7m)	4 Sheets	1.1m x 1.4m	2.4m Resin Bolts 2.4m Split Sets 0.9m Stubby Bolts	31  13 13
4.5m x 4.5m Access - Operating	Basalts	3.4	Mesh (2.4m x 3.7m)	3 Sheets	1.1m x 1.7m	2.4m Split Sets 0.9m Stubby Bolts	18  7
4.5m x 4.5m Ore Drive - Operating	Ultramafics Ore Lode	3.4	Mesh (2.4m x 3.7m)	5 Sheets	1.1m x 1.4m	2.4m Resin Bolts 2.4m Split Sets 0.9m Stubby Bolts	27  11 11

Cabling bolt recommendations for intersections and brows is the generalised parabolic arch approach based upon a standard 2m by 2m pattern with a 6m cable length i.e. (16 per 4 way intersection, 9 per 3 way intersection).

Specific ground support design for the portal, major underground infrastructure, or raisebores to surface has not been completed at this Scoping Study stage.

## Mining

Following is a description of the orebody and proposed mining method for each of the deposits considered in this Scoping Study.

### Widgie Townsite

The WTS orebody dips on average at 75° to the east and plunges to the south. The deposit has mineable horizontal widths between 5m to 20m with ore predominantly being disseminated nickel sulphide. The primary nickel sulphide orebody starts on average at 80m below the surface (320mRL) extending to 520m below the surface. The orebody is open at depth and at present is only constrained by drilling.

The deposit consists of two (2) mineable lenses both striking north-south with strike lengths up to 300m.

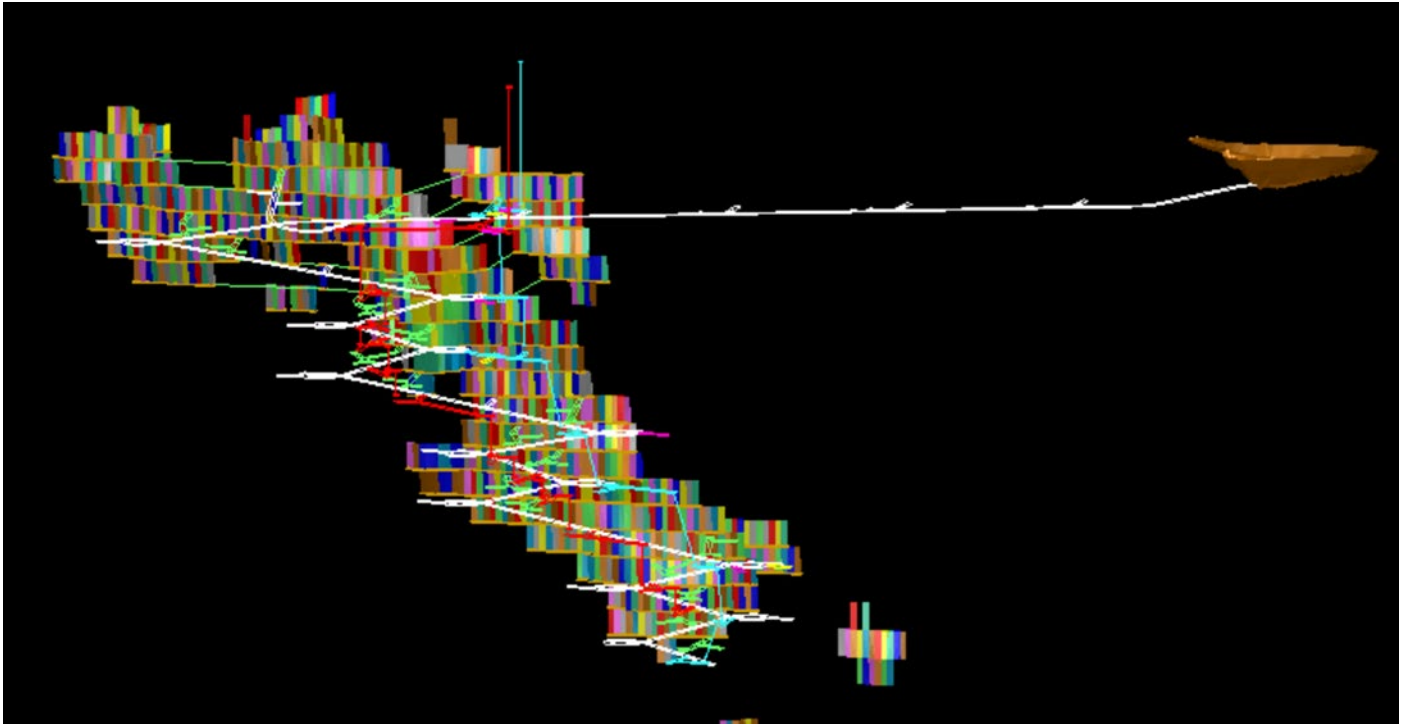

**Figure 7 - Widgie Townsite Mine Development- Isometric View facing East**

The main lens mostly sits between 10m to 20m off the basalt ultramafic contact with the minor southern lens being all in ultramafic.

The main applied mining method is “Bottom-Up Long Hole Stopping with Waste Rock Fill”. In poor ground conditions, this will revert to “Single Entry Choke Avoca with Waste Fill”. This mining method has been successfully employed on multiple occasions for similar steep dipping Komatiite nickel orebodies in the Kambalda area.

Access to the orebody it is planned via a conventional decline access from the nearby Bass Open Pit at the 305RL. This portal site was selected after an inspection of the area was completed to assess local ground conditions. The portal site in this location is below the top of fresh rock close to the weathered contact with some additional minor ground support being required. Planned dimensions for the main decline is 5.2mH x 5.0mW allowing for the use of 40t payload ejector trucks. The selected grade of the main decline is 1:7 down in line with acceptable angles for modern mining machinery.

The majority of the Main Decline design can be described as an inverted Figure 8 configuration with level spacing at 22.5m floor to floor. The extended mine exhaust has been positioned where possible in the centre of the straights to allow efficient exhaust access and convenient mine services reticulation. All mine exhaust development has been designed with drive dimensions of 5m wide x 5m high and internal extension rises with dimensions of 6m x 4m.

The second fresh air intake has been extended on the southern end of the Main Decline to provide early access and efficient infill diamond drilling positions. All secondary fresh air intake development has been designed with drive dimensions of 5m wide x 5m high. The majority of the internal secondary fresh air intake rises are planned to be 2.4m diameter and fitted with caged escapeway ladders.

There are five (5) stopping blocks planned with 4 CRF Pillars allowing for a high ore extraction ratio (Ref Figure 11).

## Gillett and Widgie 3

The Gillett orebody dips on average at 85° to the west and extends over a total strike length of 1450m. The deposit has minable horizontal widths between 3m to 15m with most ore being disseminated nickel sulphide. The minable primary nickel sulphide orebody starts on average at 150m below the surface (350mRL) extending to 420m below the surface. The orebody is open at depth and along strike in both directions. At present, the orebody is only constrained by drilling.

The deposit consists of two (2) mineable lenses both striking north-south with on average, 15m between the lenses. The main lens mostly sits between 10m to 20m off the basalt ultramafic contact with the minor western lens at times on the basalt contact (Ref Figure 8).

The main mining method for both Gillett and Widgie 3 is “Bottom Up Long Hole Stopping with Waste Rock Fill”. In poor ground conditions, this will revert to “Single Entry Choke Avoca with Waste Fill”.

The Widgie 3 orebody has a near vertical dip and extends over a total strike length of 320m. The deposit has mineable horizontal widths between 3m to 12m with most ore being matrix and disseminated nickel sulphide. The mineable primary nickel sulphide orebody starts on average at 60m below the surface 330mRL extending to 420m below the surface. The orebody remains open at depth.

The deposit consists of a single mineable lens located on the basalt ultramafic contact. There is a small defined splay at the south end, which may become more significant with further drilling.

Access to both orebodies is via a conventional decline access from the existing Widgie 3 Open Pit at the 290mRL. In total, there are four (4) mine portals planned to be developed from the Widgie 3 pit, with 1 as the main mine access, 2 as mine exhausts (one for each orebody) and 1 as a dedicated fresh air intake for Widgie 3. Planned dimensions for the main decline and ventilation portals is 5.2mH x 5.0mW, allowing for use of 40t payload ejector trucks. The selected grade of the main decline is 1:7.

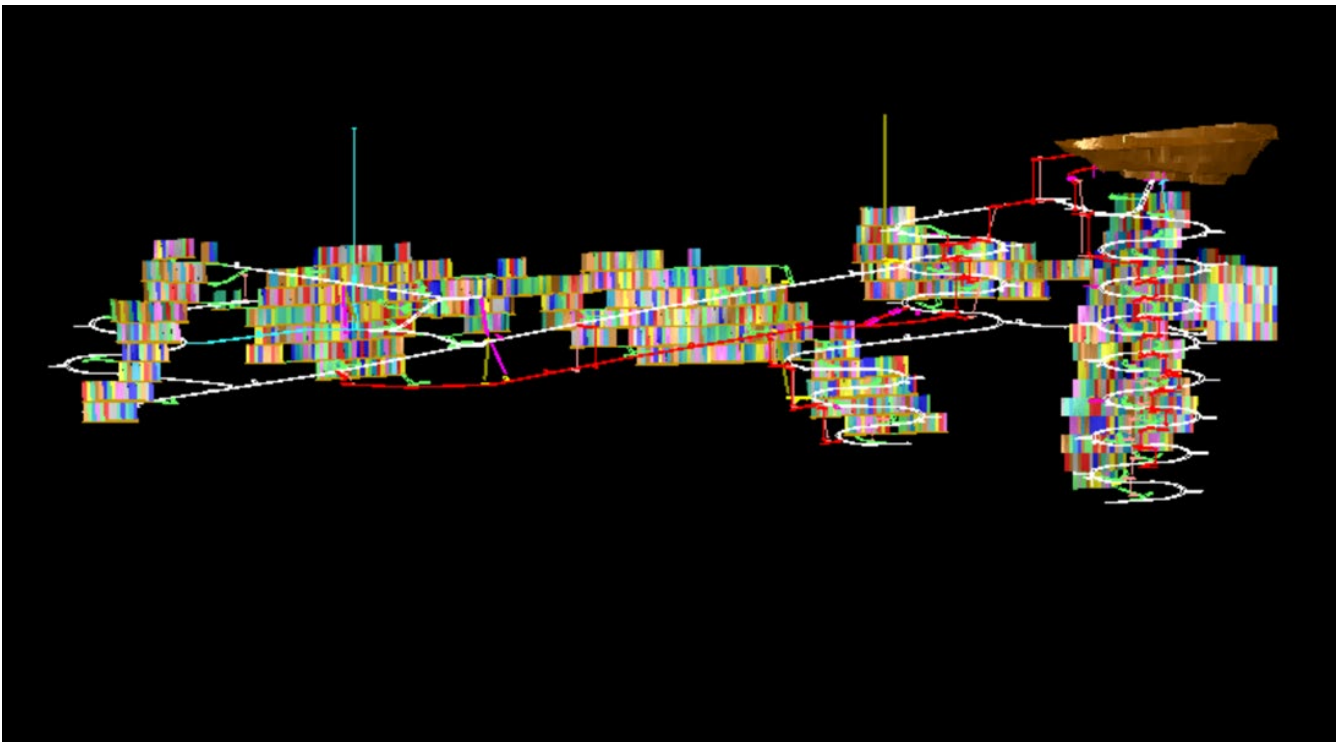

**Figure 8 - Isometric View of Gillett & Widgie 3 Mine Design (facing east)**

The first leg of the Main Gillett Decline from the 290mRL to the 225mRL has been designed to cross the ultramafic unit between the Widgie 3 and Gillett basalt units. It then settles on a north south strike on average 50m from the Gillett open contact position in the basalt unit.

The majority of the main decline design is a standard Figure 8 design with level spacing at 22.5m floor to floor. The extended mine exhaust has been positioned where possible in the centre of the straights to allow efficient exhaust access as well as convenient mine services reticulation. All mine exhaust development has been designed with drive dimensions of 5m high x 5m wide with planned extension rises of dimensions of 6m x 4m. The mine exhaust will also serve as the secondary means of egress. In the lower section of the mine, it is planned to mine off this exhaust development. This will require a set of airlock doors to be installed at 100mRL. At the north end the ore is accessed by two inclines starting at the 30mRL reaching up to the 175mRL.

The Widgie 3 decline commences at the 260mRL as a major intersection off the Gillett Main decline. The Widgie 3 decline design consists of the same standard figure 8 design with level spacing at 22.5m floor to floor. The extended mine exhaust has been positioned where possible in the centre of the straights to allow efficient exhaust access as well as convenient mine services reticulation. All mine exhaust development has been designed with drive dimensions of 5m high x 5m wide with extension rises with dimensions of 6m x 4m. The mine exhaust will also serve as the secondary means of egress. A second separate fresh air intake is designed from a fresh air portal in the pit at the 290mRL connecting to the Widgie 3 Decline at the 248mRL.

The Gillett mine plan comprises of six (6) stoping blocks with 3 CRF Pillars allowing for a high extraction ratio. The mine itself is separated into 5 zones along strike to keep loader tram distances efficient. (Ref Figure 12 and Figure 13)

The Widgie 3 mine plan comprises of four (4) stoping blocks with 3 CRF Pillars positioned to allow for a high extraction ratio. There is no plan to extract the Widgie 3 Pit crown pillar as access to the mine would potentially be lost.

## **Armstrong**

The Armstrong Orebody dips at an average of 55° to the south-west with minable horizontal widths between 1.5m to 25m. The orebody starts at the base of the current Armstrong open pit 230mRL (105m below the surface) and terminates at depth at the 0mRL (335m below the surface). The Armstrong orebody plunges to the north and extends over a total strike length of 250m (Figure 9).

The deposit consists of a single mineable lens striking north-west to south-east. The main lens mostly sits on the basalt ultramafic contact with a felsic dyke and some large faults intersecting the north end of the orebody. The orebody terminates at depth being intersected by a large granite intrusion.

The main applied mining method employed will be “Bottom Up Long Hole Stopping with Waste Rock Fill”. In poor ground conditions, this will revert to “Single Entry Choke Avoca with Waste Fill”.

Access to the orebody is planned via a conventional decline developed from the existing Armstrong Open Pit at the 263mRL. There is also a separate small 2m high x 2m wide escapeway access designed in the east face of the pit to provide a secondary means of egress. The mine exhaust is planned as a 5m x 5m rise from the underground mine at the 262mRL into a pit bench located on the 280mRL. Planned dimensions for the main decline is 5.2mH x 5.0mW with a 1:7 gradient allowing for the use of 40t ejector trucks.

The Armstrong access portal is planned to be developed in the eastern face of the Armstrong pit in good competent basalt rock. The majority of the main decline design is a standard Figure 8 design with level

spacing at 17.5m floor to floor catering for the relatively shallow dip. The majority of the main decline is positioned in the lower basalt unit with only some minor sections in the middle Ultramafic.

The extended mine exhaust has been positioned where possible in the centre of the straights to allow efficient exhaust access as well as convenient mine services reticulation. All mine exhaust development has been designed with drive dimensions of 5m high x 5m wide with extension rises with dimensions of 6m x 4m. The mine exhaust will also serve as the secondary means of egress extension. There is a separate 50m lower escapeway rise that is planned to be developed as a 1.5m diameter raise bore hole.

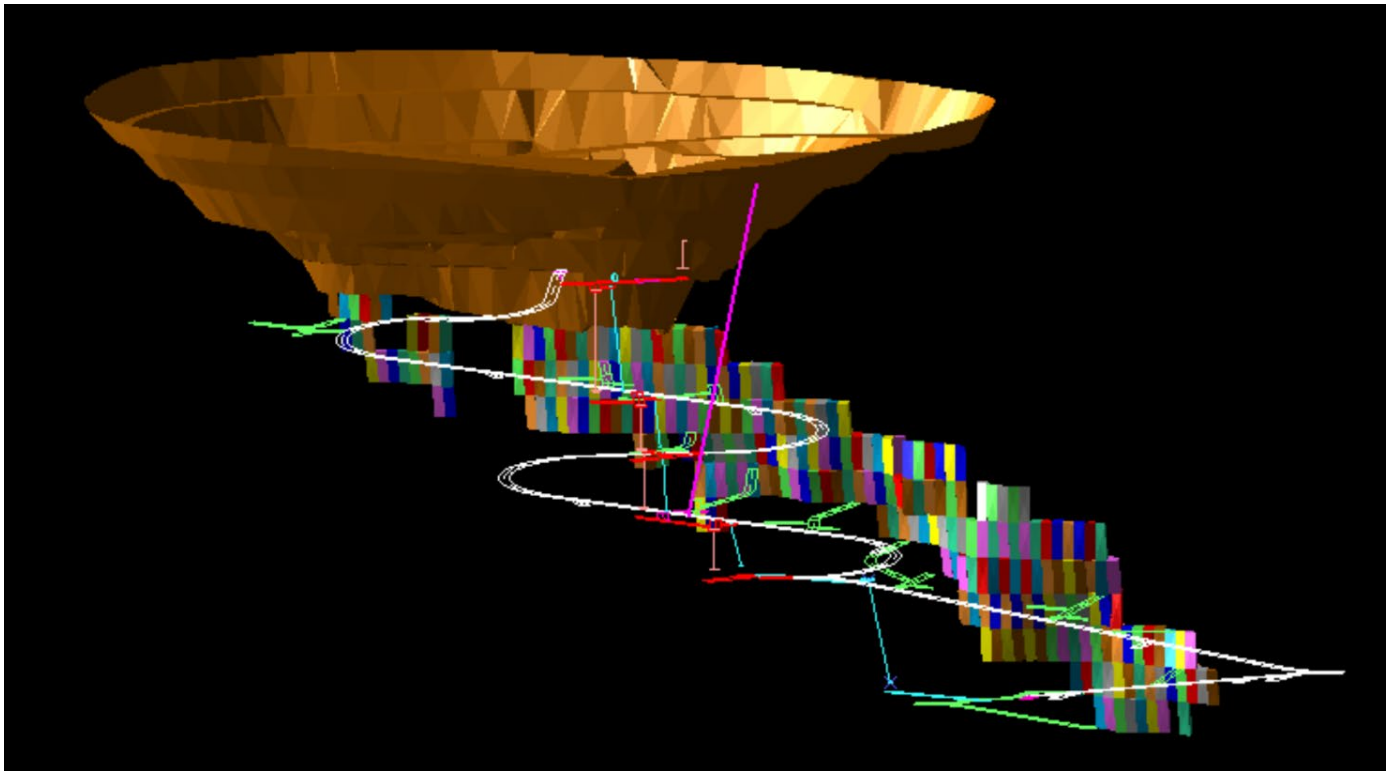

**Figure 9 - Isometric View of Armstrong Mine Design (facing west)**

## 132N

The 132N orebody dips on average near vertical with mineable horizontal widths between 2m to 10m. The orebody starts at the base of the current 132N open pit 300mRL (80m below the surface) and extends at depth to the 50mRL (330m below the surface). The 132N orebody plunges to the north and extends over a total strike length of 220m (Ref Figure 10).

The deposit consists of multiple mineable lenses striking north-south. The main lens mostly sits on the basalt ultramafic contact with some sections of high-grade channel structures in the basalt. The orebody is open at depth and may continue down the plunge angle of the mineralised ultramafic syncline.

The main applied mining method is “Bottom Up Long Hole Stopping with Waste Rock Fill”. In poor ground conditions, this will revert to “Single Entry Choke Avoca with Waste Fill”.

Access to the orebody is via a conventional decline access from the existing 132N open pit with a portal developed from the 333mRL. The mine exhaust is planned as a 5m x 5m rise from the underground mine at the 326mRL into a pit bench located on the 358mRL. The secondary means of egress is a separate

1.5m diameter raise bore rise to a pit bench on the 359mRL. Planned dimensions for the main decline is 5.2mH x 5.0mW of 1:7 gradient allowing for the use of 40t payload ejector trucks.

The 132N access portal is planned to be developed in the northern face of the 132N pit in good competent basalt rock. The majority of the main decline design is a strafing Figure 8 design with level spacing at 22.5m floor to floor. The main decline is positioned in the footwall basalt unit with on average 50m from the mineralised ultramafic contact.

The extended mine exhaust has been positioned where possible in the centre of the straights to allow efficient exhaust access as well as convenient mine services reticulation. All mine exhaust development has been designed with drive dimensions of 5m high x 5m wide with extension rises with dimensions of 6m x 4m. The mine exhaust will also serve as the secondary means of egress extension. There is a separate 18m lower escapeway rise that is planned to be developed as a 1.5m raise bore hole for the bottom level at the 52.5mRL.

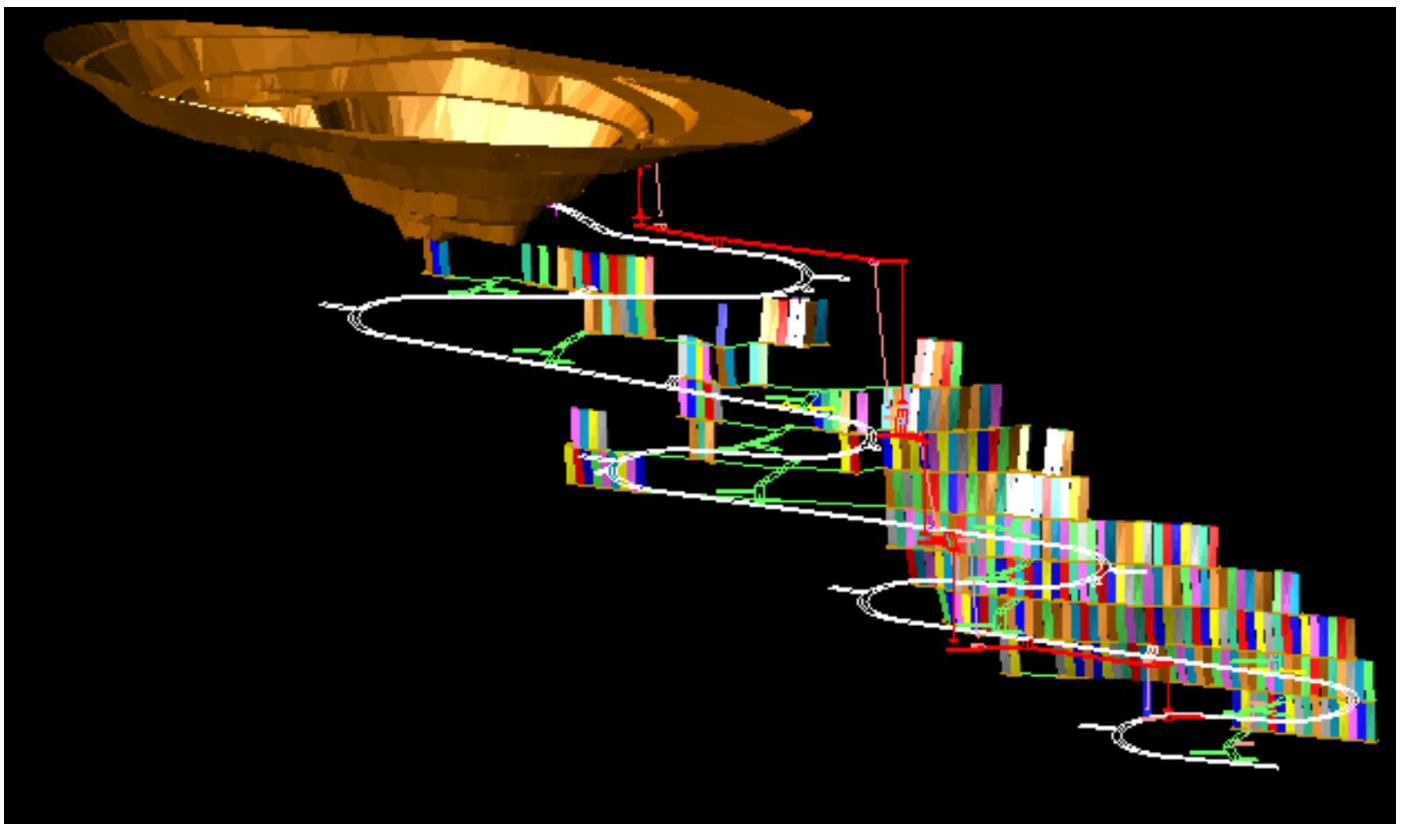

**Figure 10 - Isometric View of 132N Mine Design (facing west)**

There are two (2) stoping blocks planned with 1 main CRF Pillar. It is planned to extract the small Crown Pillar under the pit at the end of the mine life (Ref Figure 15).

## Lateral Mine Development

The selected dimensions for the main declines is (5.2mH x 5.0mW), which is suitable for modern electric hydraulic development drills as well as diesel powered loaders and trucks. The lateral exhaust development for the mines is planned at 5.0mH x 5.0mW along with the fresh air intake development. Access for the levels in most cases is planned at 5.0mH x 5.0mW for the first 35m to allow room for a level sump and stockpile. Further level development towards the ore body is planned at 4.5mH x 4.5mW. All ore drive development has been planned at 4.5mH x 4.5mW with over width ore stripping included where relevant.

**Table 12 - Underground Mine Lateral Development Summary**

MINE	Main Decline (5.2mH x 5.0mW)	Access/Exhaust (5.0mH x 5.0mW)	Level Access (4.5mH x 4.5mW)	Ore Drive (4.5mH x 4.5mW)	Total (m)
<b>WTS</b>	3,706	3,290	362	3,752	<b>11,110</b>
<b>GW3</b>	8,060	7,661	1442	8,571	<b>25,734</b>
<b>ANM</b>	1,446	1,107	569	1,600	<b>4,722</b>
<b>132N</b>	2,024	1,541	253	1,595	<b>5,413</b>
<b>TOTAL</b>	<b>15,236</b>	<b>13,599</b>	<b>2,626</b>	<b>15,518</b>	<b>46,979</b>

**Vertical Mine Development**

The mine designs require capital vertical development for both the mine ventilation system as well as to provide the required secondary means of egress. It is crucial that these excavations are completed as fast as possible with the lateral development to ensure mine development targets can be achieved.

Internal ventilation exhaust rises are planned to be excavated with dimensions of 6m x 4m and various vertical heights dependent on level spacings. The majority of these excavations will be completed first by installing a vertical 1.5m diameter raise bore hole with a contractor provided raise drill rig. This initial hole will then be stripped out to the final excavation size by drilling and firing 89mm blast holes.

Escapeway rises are required to complete the essential secondary means of egress network. These rises will be installed using a raise bore machine and fitted with caged escapeway ladders. These rises are also designed just off vertical to make the ladderways easier to install and climb.

The WTS mine has two (2) surface vertical shafts planned. The first surface shaft is planned 5m diameter and will be the main mine exhaust rise. The second surface shaft is planned as a second fresh air intake with a cross section area of 2.4m diameter. The GW3 mine has a surface intake shaft planned for the northern end of the mine to be developed at 5m diameter.

**Table 13 - Underground Mine Capital Vertical Development Summary**

MINE	Surface Shaft (5.0m Dia)	Surface Shaft (2.4m Dia)	Exhaust Rise (6.0mH x 4.0mW)	Fresh Air Rise (2.4m Dia)	Escapeway Rise (1.5m Dia)	Total (m)
<b>WTS</b>	115	118	274	286	81	<b>874</b>
<b>GW3</b>	217	0	592	0	770	<b>1,579</b>
<b>ANM</b>	0	0	111	0	169	<b>280</b>
<b>132N</b>	0	0	228	0	257	<b>485</b>
<b>TOTAL</b>	<b>332</b>	<b>118</b>	<b>1,205</b>	<b>286</b>	<b>1,277</b>	<b>3,218</b>

Vertical slot rises (780mm diameter) will be required for the blind up hole stopes and panels under the CRF Crowns. Long hole sinze slots (3m x 3m) will also be required for the bottom-up mining panels.

**Table 14 - Underground Mine Operating Vertical Development Summary Mining Methods**

MINE	Uphole Slot (780mm Dia)	Downhole Winze (3m x 3m)	Total (m)
WTS	1,408	1,562	2,970
GW3	2,090	2,728	4,818
ANM	381	228	609
132N	630	428	1,058
<b>TOTAL</b>	<b>4,509</b>	<b>4,946</b>	<b>9,455</b>

**Stoping Sequence**

For each mining sequence, it is important to maintain an efficient and productive stoping cycle to ensure the number of stoping fronts is balanced with the backfilling and production drilling. Keeping all activities active will smooth the resource requirements and keep the machinery and manning levels stable.

For all the deposits considered in this Scoping Study, where possible, stopes are planned to be extracted utilising a ‘Bottom-Up’ mining approach to maximise ore extraction and minimise stope dilution.

The **Widgie Townsite** mine plan has production activities occurring simultaneously in five (5) separate mining stages. These stages are divided by 4 level CRF Pillars. Stages 1 & 2 has mining activities occurring on the smaller southern ore body where there is future possible additional ore to be mined (Ref Figure 11 ).



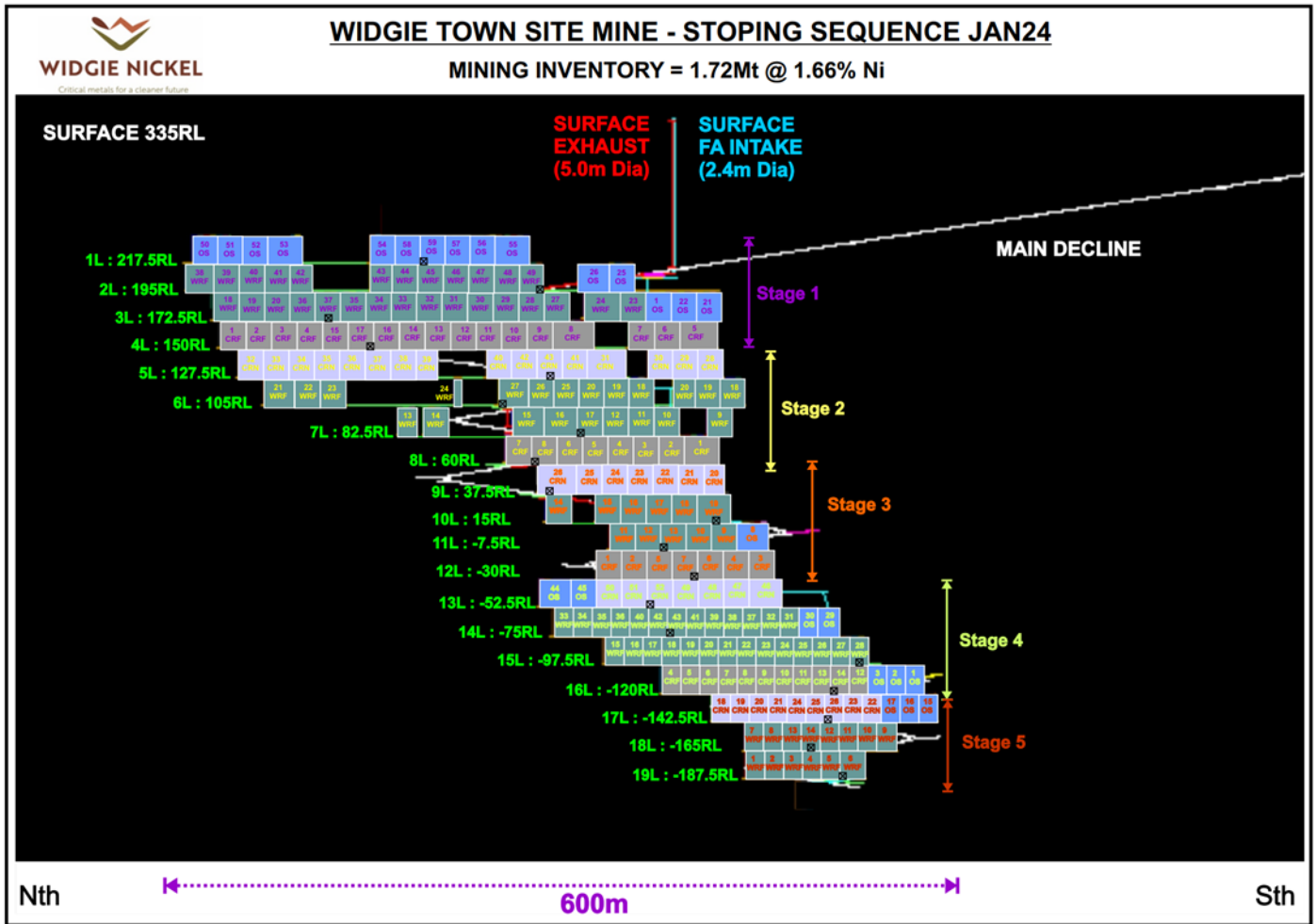

Figure 11 - Long Section Facing East Showing Widgie Townsite Mining Sequence

The **Widgie 3** mine plan has production activities occurring simultaneously in three (3) separate mining stages. These stages are divided by a single CRF Pillar and a large low grade contact zone. Stage 2 also has mining activities occurring on the smaller southern ore body (ref Figure 12).

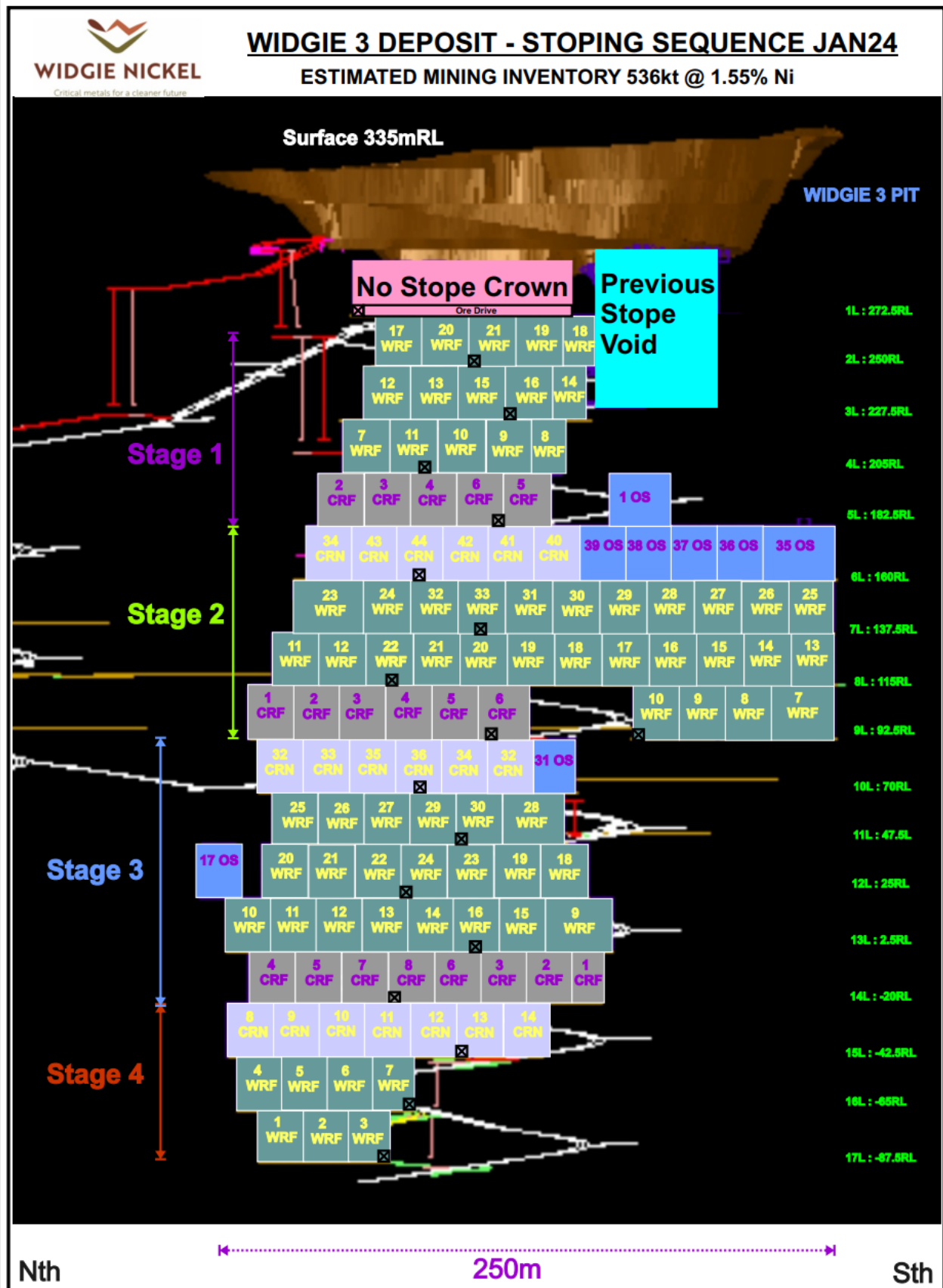

Figure 12 - Long Section Facing East Showing Widgie 3 Mining Sequence

The **Gillett** mine plan has production activities occurring simultaneously in six (6) separate mining stages. These stages are divided by 2 level CRF Pillars also divided along strike to reduce loader tram distances. Stages 1 & 2 have mining activities occurring on the smaller southern ore body that will be the first source of production ore (Ref Figure 13).

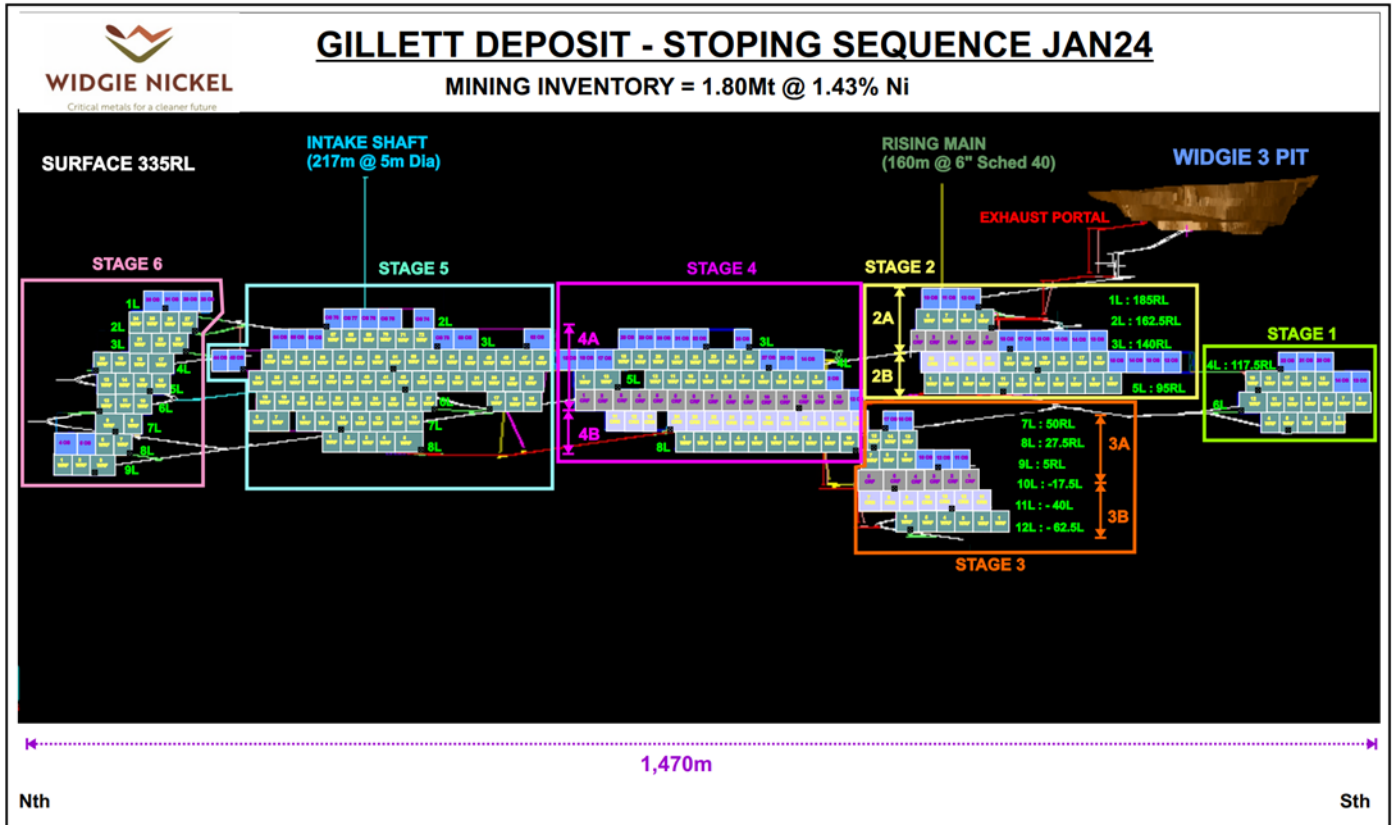
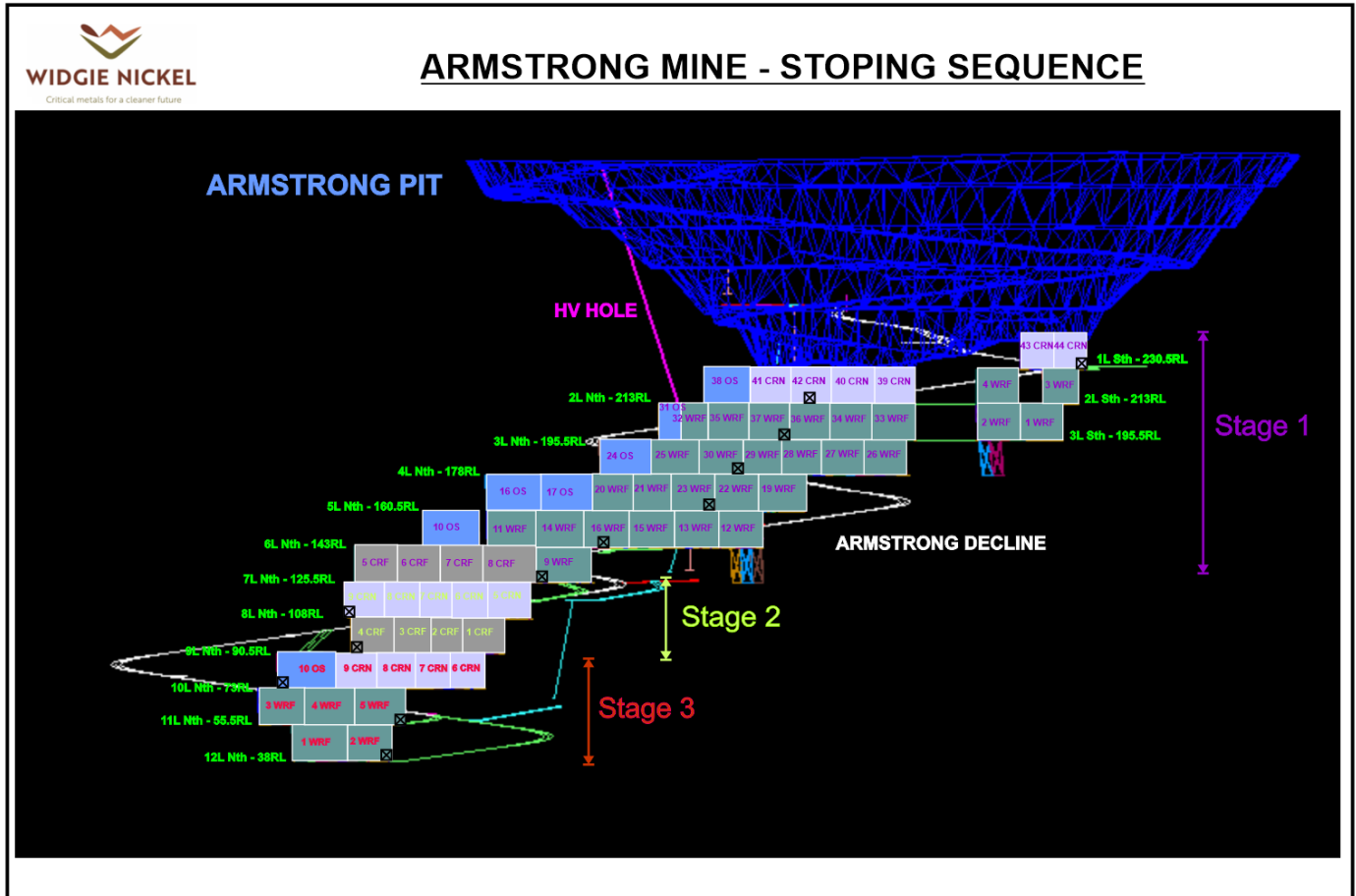

Figure 13 - Long Section Facing East Showing Gillett Mining Sequence

The **Armstrong** mine plan has production activities occurring simultaneously in three (3) separate mining stages. These Stages are divided by 2 full level CRF Pillars planned on the 7L and 9L. Stage 1 - South has mining activities occurring on the smaller southern ore body where there is future possible additional ore to be mined (Ref Figure 14).



**Figure 14 - Long Section Facing East Showing the Armstrong Stopping Sequence**

The **132N** mine plan has production activities occurring simultaneously in two (2) separate mining stages. These stages are divided by a CRF Pillar planned to be installed on the 6L for the largest northern pod. The southern economic mineralisation is divided into several small pods where there is possible future additional ore to be mined (Ref Figure 15).

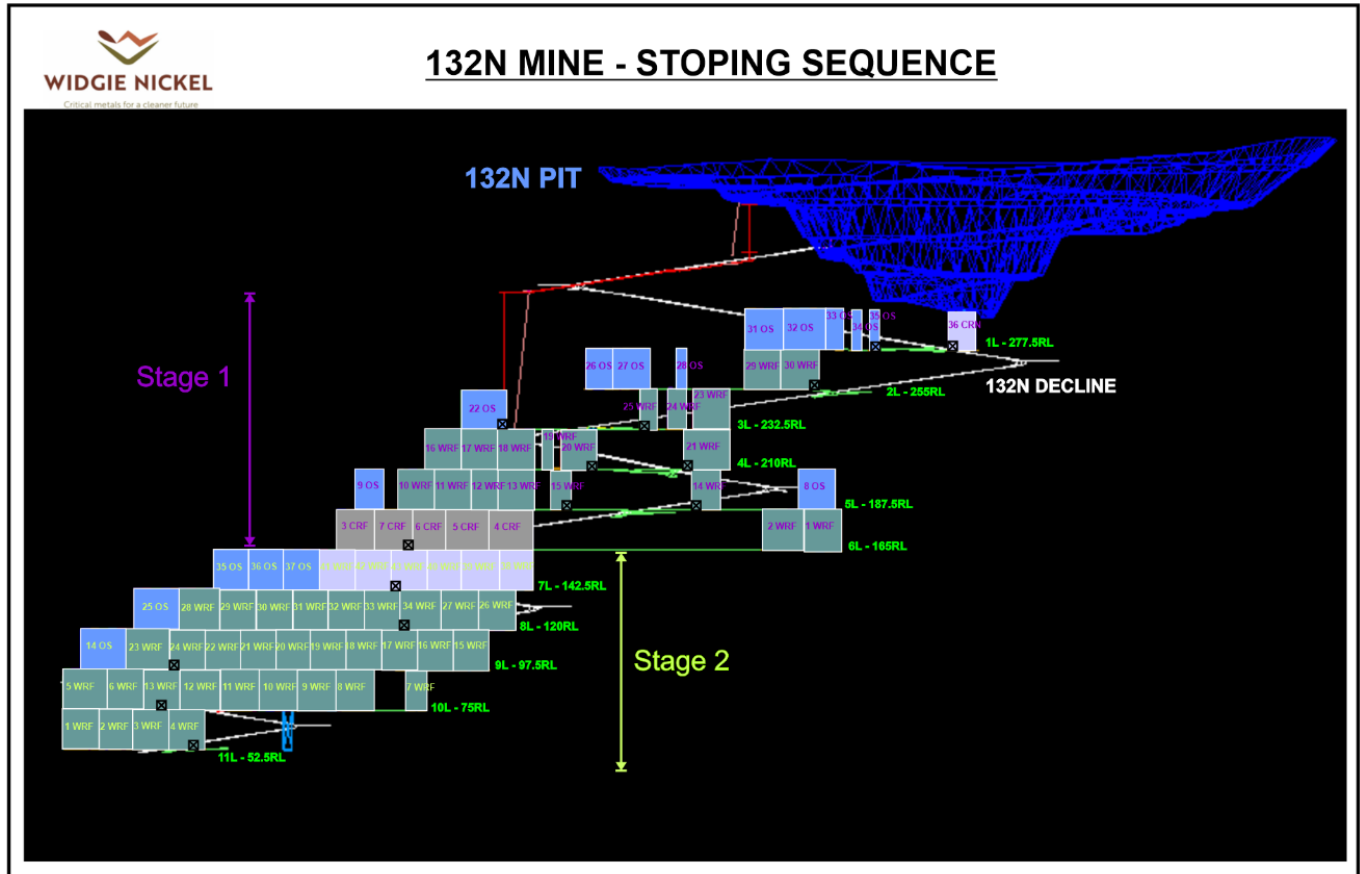

**Figure 15 - Long Section Facing East Showing the 132N Stopping Sequence**

## Mine Infrastructure

### Mine Ventilation

Following is a brief description of the ventilation circuits for each of the deposits considered in this Scoping Study.

### Widgie Townsite

The initial temporary primary ventilation circuit will first be pressurised by 3 x 110kW axial fans to be installed in a ventilation wall at the 207mRL. This is a temporary primary ventilation configuration with the 2.4m diameter surface shaft first being utilised as the mine exhaust whilst the 5.0m shaft excavation is completed.

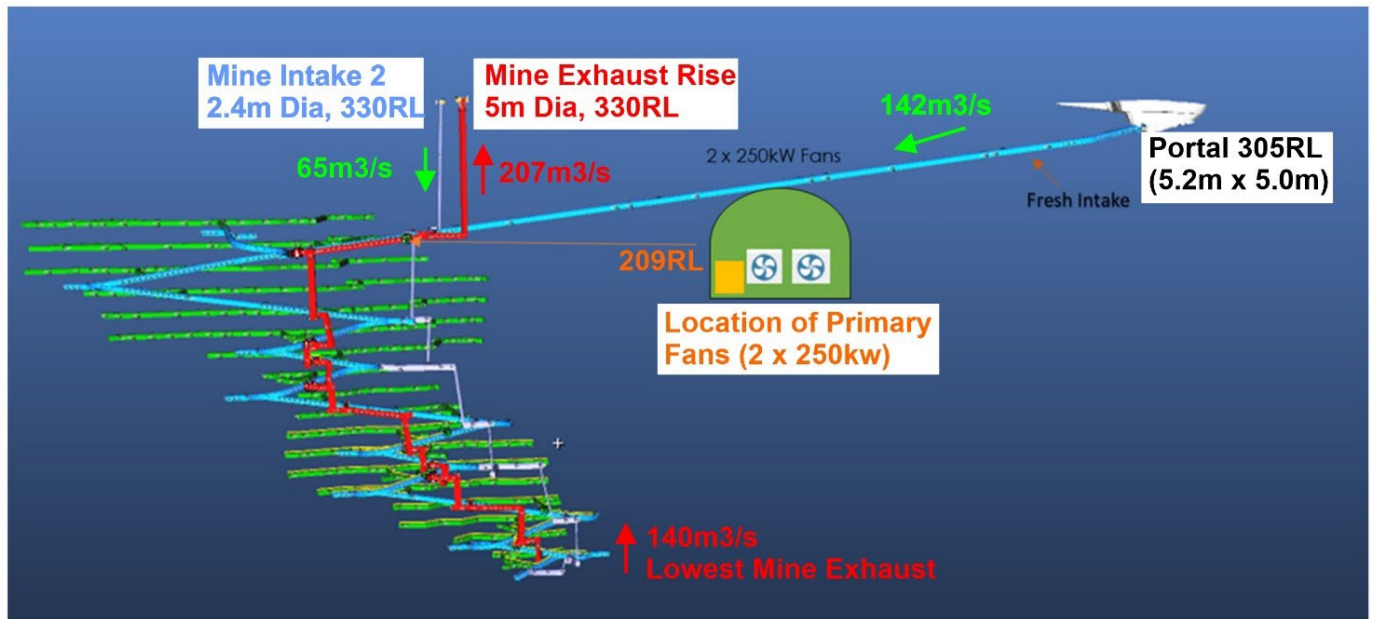

**Figure 16- Long Section facing east showing Widgie Townsite Primary Ventilation Circuit**

The WTS primary ventilation circuit is designed as a series of circuits where the intake air supply is initially introduced from the portal (305mRL) via a 2 stage 220kW secondary fan. The first vertical primary exhaust is to be established at the 207mRL as a 2.4m diameter 118m vertical surface shaft. Temporary exhaust ventilation power will be provided by the installation of 3 x 110kW axial flow fans to be installed at the bottom of the 2.4m diameter rise in a wall. This intermediate primary ventilation circuit will allow the mine to be continuously developed and provide time for the establishment of the main surface exhaust shaft.

The final vertical primary exhaust is to be established at the 209mRL as a 5.0m diameter 115m vertical surface shaft. Primary exhaust ventilation power will be provided by the installation of 2 x 250kW axial flow fans to be installed at the bottom of the rise in a wall. This main mine exhaust will then be extended to depth (-144mRL) by a separate exhaust network comprising of 5m x 5m lateral drives and 6m x 4m vertical rises.

Ventilating requirements have been determined based upon a minimum requirement of 149.4cu.m per second. Maximum output as per design is 207cu.m.

### Widgie 3 and Gillett

The Widgie 3 and Gillett development can be viewed as a single underground mine. As the planned workings access two separate orebodies, the design requires two internal separate primary ventilation circuits.

The primary ventilation circuit planned for Widgie 3 has both an exhaust portal and intake portal developed from the Widgie 3 Pit. The primary exhaust is to be established at the 305mRL with this network also serving as the mine's secondary means of egress. The main mine intake will be developed from a separate intake portal located at the (290mRL). This intake will link into the Widgie 3 main decline at the 248mRL, which will serve as the sole intake for Widgie 3 below that point.

Primary exhaust ventilation power for Widgie 3 will be provided by the installation of a single 250kW axial flow fan to be installed in a wall accessible by the exhaust portal at the 300mRL. This main mine exhaust will then be extended to depth (66mRL) by a separate exhaust network comprising of 5m x 5m lateral drives and 6m x 4m vertical rises.

The primary ventilation circuit for Gillett has an exhaust portal planned to be developed from the Widgie 3 Pit with the main Gillett decline serving as the primary intake. Some intake air is also designed to flow from the Widgie 3 Intake (248mRL) back up to the main Gillett decline. The Gillett primary exhaust is to be established at the 305mRL with this network also serving as the mine’s secondary means of egress. The Gillett completed Gillett primary ventilation circuit also includes a northern surface vertical intake shaft to be developed to a depth of 217m at a planned diameter of 5m.

Primary exhaust ventilation power for Gillett will be provided by the installation of a 3 x 110kW axial flow fans to be installed in a wall accessible by the exhaust portal at the 304mRL. This main mine exhaust will then be extended both laterally and to depth (2mRL) by a separate exhaust network comprising of 5m x 5m lateral drives and 6m x 4m vertical rises. An additional set of 2 x 110kW booster fans will also be required in a further northern position in the exhaust circuit. A set of automated airlock doors are designed to be installed in the Gillett exhaust network at the 75mRL. These doors will allow efficient mining to occur in the lower exhaust decline from the 79mRL to the 2mRL.

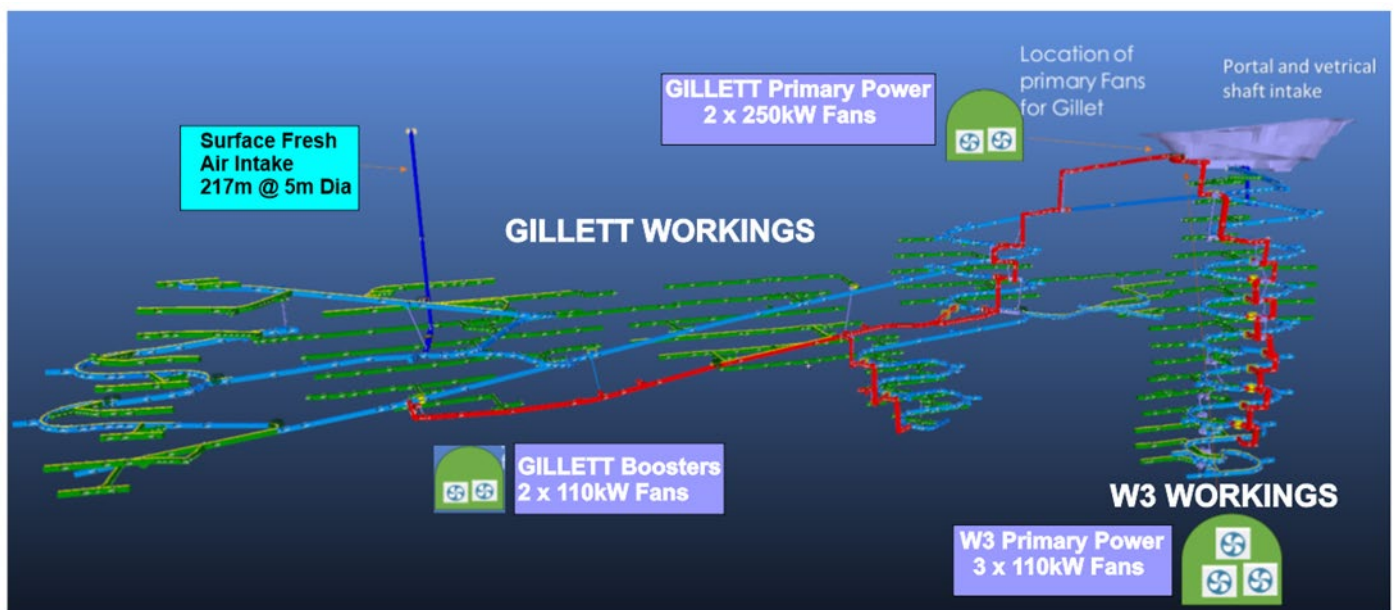

**Figure 17 - Long Section Facing East Showing GW3 Primary Ventilation Circuit**

Widgie minimum primary ventilating requirement is 101.1cu.m per second with design maximum output 170cu.m per second.

Gillett minimum ventilating requirement is 134.3cu.m per second with design maximum output of the proposed system 210cu.m per second.

## Armstrong

The Armstrong primary ventilation circuit is designed as a series circuit where the intake air supply is introduced from the portal (282mRL), flowing down the decline. The air is reused from one level to the next as it flows down the decline until it reaches the lowest level of the primary ventilation circuit where it is drawn up through the return air rise system. The air is drawn by a primary ventilation fan installation on the 262mRL. This installation is designed with 3 x 110kW axial flow fans installed in a ventilation wall with a horizontal orientation. The final return airway rise is located on the pit bench at 280mRL.

The return airway will be extended lower in the mine via exhaust access drives developed from the main decline to the north/east at the (261mRL, 209mRL, 184mRL, 148mRL, 125mRL). These exhaust access drives will be developed at 5.0mH x 5.0mW and be linked between levels with 6m x 4m long hole rises.

The main mine exhaust will be located on the 280mRL pit bench 20m to the north and 20m above the main decline portal position.

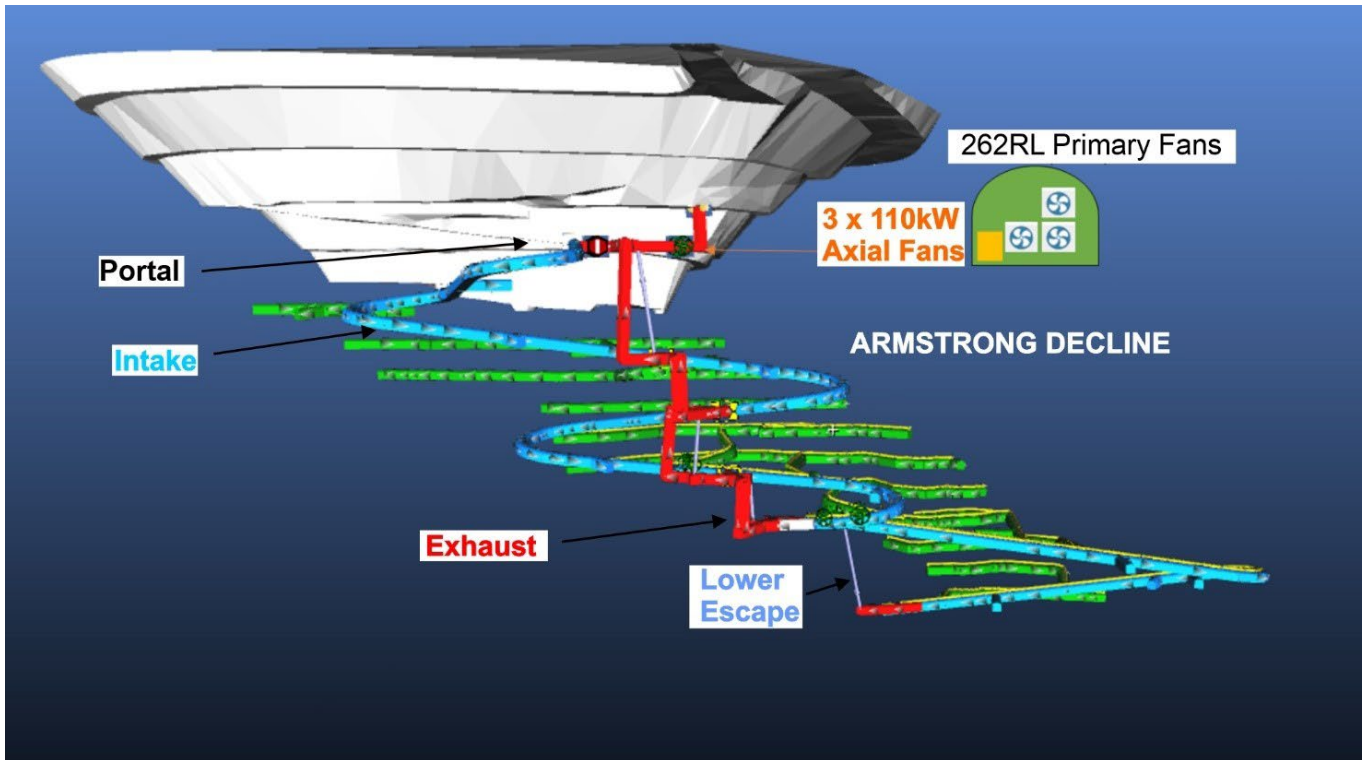

**Figure 18 - Long Section Facing West Showing Armstrong Primary Ventilation Circuit**

## 132N

The 132N primary ventilation circuit is designed as a series circuit where the intake air supply is introduced from the portal (334mRL), flowing down the decline. The air is reused from one level to the next as it flows down the decline until it reaches the lowest level of the primary ventilation circuit where it is drawn up through the return air rise system. The air is drawn by a primary ventilation fan installation on the 322mRL. This installation is designed as 3 x 110kW axial flow fans installed in a ventilation wall with a horizontal orientation. The final return airway rise is located on the pit bench at 358mRL.

The return airway will be extended lower in the mine via exhaust access drives developed from the main decline at the (320mRL, 225mRL, 169mRL, 115mRL, 72mRL). These exhaust access drives will be developed at 5.0mH x 5.0mW and be linked between levels with 6m x 4m long hole rises. The main mine exhaust will be located on the 358mRL pit bench 48m to the north and 25m above the main decline portal position.



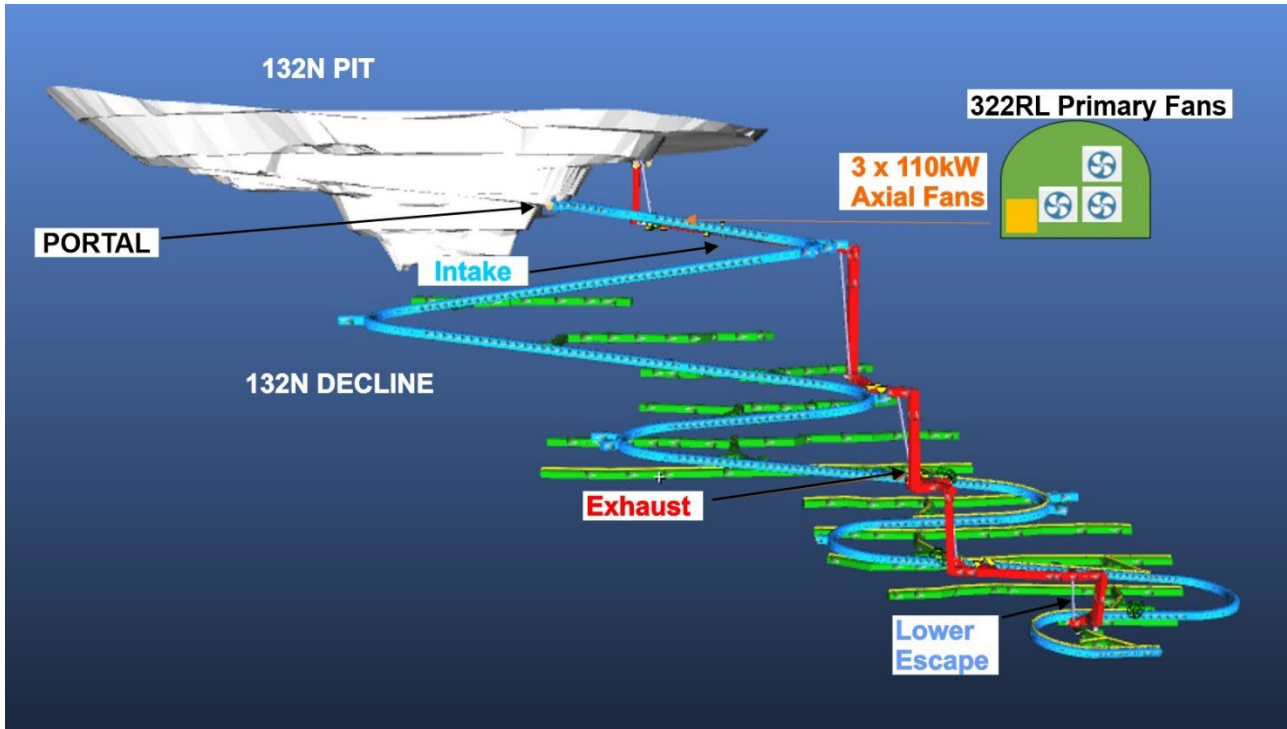

Figure 19 - Long Section Facing West Showing 132N Primary Ventilation Circuit

**Secondary Ventilation**

Secondary ventilation will be achieved using 110kw and 180kw twin stage fans as duty dictates. Fans will be fitted with variable speed drives depending on location in order to “dial in” the required airflow thus reducing power draw.

**Mining Fleet**

The proposed mining fleet considered in this Study from which ventilating requirements have been determined consists of the following:

**Table 15 - Proposed Mining Fleet**

Unit	Make	Model
Electric/Hydraulic Jumbo	Sandvik	DD421/422
Electric/Hydraulic LH Rig	Sandvik	DL431
517 Loader (8m <sup>3</sup> )	Sandvik	LH517
40t Haul Truck	CAT	AD40
Integrated Tool Carrier	Volvo	L90
Grader	CAT	12H
Light Vehicles	Toyota	Landcruiser 79 series

The Widgie Townsite mining fleet is scheduled to peak at 2 jumbos, 3 loaders and 3 underground trucks. The Widgie 3 mining fleet is scheduled to peak at 1 jumbo, 2 loaders and 2 underground trucks. The Gillett mining fleet is scheduled to peak at 2 jumbos, 2 loaders and 3 underground trucks. The Armstrong mining fleet is scheduled to peak at 1 jumbos, 2 loaders and 2 underground trucks.

The 132N mining fleet is scheduled to peak at 1 jumbo, 2 loaders and 2 underground trucks.

## Secondary Means of Egress

Primary access throughout the mines will be via the main haulage declines. A secondary means of egress for each mine will be established below each level prior to the commencement of stope blasting on that level. The secondary means of egress routes are designed as a network of linking 1.5m diameter raise bore holes fitted with certified caged steel ladders. Level development drives forming part of the return airway network will also form part of the secondary means of egress to be accessed via air-lock man doors where design dictates use of lateral development rather than raise bores.

The primary means of egress from each level will be to exit the level access to the haulage decline, then travel up the decline to the surface. The secondary means of egress network is established for use only in case of emergencies or when the main haulage way is blocked.

As the primary ventilation circuit is extended at depth with return airway raises, ventilation stoppings will be built at all connections to the decline (except for the lowest connection at any given time) to ensure the escapeway system is maintained in the intake (fresh) air circuit.

The escapeway system for Gillett/Widgie 3, Armstrong and 132N is not planned to be located in the direct fresh air circuit. Fixed refuge chambers will be located throughout the operation for use in the event of a fire underground. Locations for the refuge chambers will be such that all areas of the underground operation will be within 750 metres walking distance of a refuge chamber at all times. For WTS, the secondary means of egress will be located in the second fresh intake that links to the surface via the 2.4m diameter surface shaft. All other lower escapeway sections at WTS will also be located in the fresh air intake providing further options for mine escape given the depth of planned workings.

Each mine will also have a VHF radio system with a dedicated emergency radio channel that can be used to warn personnel of an emergency. Once activated emergency procedures will dictate that underground personnel immediately make their way to the nearest refuge chamber on hearing the emergency call.

## Mine Power

For WTS and Gillett/Widgie 3, underground mine high voltage power supply will be provided by the main Project 33kV overhead powerline. The powerline will connect to a surface high voltage installation located near each mine portal. This installation will consist of 2 x 2MVA 33kV/11kV transformer/substations, and a 1MVA 11kV/415V transformer/substation. High voltage power will then be provided to the underground mine through 11kV 95mm high voltage cables with numerous 2MVA 11kV/1000V transformer/substations installed throughout the mine. Lower voltage 415V power will also be supplied for the office, workshops and other surface installations.

The Armstrong underground mine high voltage power supply will be provided by the Project 11kV overhead powerline. This powerline will connect to a surface high voltage installation located near the Armstrong open pit. This final installation will consist of a 1MVA 11kV/415V transformer/substation. High voltage power will be provided to the underground mine by a 70mm 11KV HV cable run down a 225m cased surface bore hole to a 2MVA 11kV/1000V transformer/substation located underground at the 150mRL. Lower voltage 415V power will also be supplied for the office, workshops, and other surface installations.

The 132N underground mine high voltage power supply will be provided by the same 11kV overhead powerline feeding Armstrong. This powerline will connect to a surface high voltage installation located near the 132N open pit. This final installation will consist of a 1MVA 11kV/415V transformer/substation. High voltage power will be provided to the underground mine by a 95mm 11KV

cable run down the 360mRL to 326mRL escapeway rise. A 2MVA 11kV/1000V transformer/substation is planned to be installed underground at the 171mRL. Lower voltage 415V power will also be supplied for the office, workshops and other surface installations.

## Underground Mine Pumping

Hydrogeology reports and historical records indicate the mine areas and surrounding rocks to be relatively dry. Most of the mine water that will be required to be pumped, will be generated from dust suppression whilst being used in mining machines during the mining process. Water pumped from each of the underground mines will be used in water recirculation circuits and sent back underground through mostly gravity feed systems for water supply. Each mine system will also have a water overflow discharge provision.

## Mine Water Supply

Each mine is designed to have a re-circulating mine water supply system. The pumped water is planned to be discharged to lined surface dams, which will have a central spillway. Water pumped from the mines will then flow over the spillway into the clean half of the dam. From here it will be transported by float activated pumps, to two (2) main water supply tanks (80kl) that will feed the mine water supply via 110mm poly pipelines. Engineered pressure reducers will be installed at regular intervals in the mine water supply line for each mine. The cost of the poly line and pressure reducers has been allowed for in the Main Decline face advance costs.

## Mine Stope Optimiser (MSO) Process

After a review of the MRE for each deposit, potential mining methods and resulting cut-off grades were assessed. The estimated generated net revenue per ore tonne (after royalties) for the Project using the studies financial assumptions is \$326/t. The total operating cost per tonne of ore for the operation is \$161/t milled so there is a considerable operating profit margin. Based on these figures, a further degree of conservatism was retained in the final selection of a 0.9% Ni Cut Off Grade (**COG**) for the MSO process.

## MSO Results

The MSO process created individual stoping panels of strike length 5m for each of the Resources. The stope shapes were created in line with each mine design using the planned vertical floor to floor level spacing. Separate ore drive shapes were later created for each level with the ore drive material then removed from each scheduled stoping panel. MSO parameters added to the raw shapes were in accordance with the following table rules.

**Table 16 - Applied MSO Parameters**

MSO PARAMETER	Unit	WTS	W3	GLT	ANM	132N
Applied COG	%Ni	0.9	0.9	0.9	0.9	0.9
Minimum Mining Width	m	1.5	1.5	1.5	1.5	1.5
Maximum Stope Width	m	100	100	100	100	100
HW Dilution	m	0.25	0.25	0.25	0.25	0.25
FW Dilution	m	0.25	0.25	0.25	0.25	0.25
Stope Vertical Height	m	22.5	22.5	22.5	17.5	22.5

Output data for each stoping panel included:

- Stope Number
- Tonnes (t)
- Ni (%)
- Cu (ppm)
- Co (ppm)
- As (ppm)
- Pd (ppm)
- Pt (ppm)
- Fe (%)
- MgO (%)
- Sulphur (%)

The resulting total MSO material is not a final indication of the economic Production Target as each stope was further assessed in conjunction with the mine plan, schedule, practical mining realities, ore processing and product marketing factors.

**Table 17 - MSO Results**

MSO INTERROGATION RESULTS	Unit	WTS	W3	GLT	ANM	132N
Number of Stopes	#	833	400	788	247	304
Stope Vertical Height	m	22.5	22.5	22.5	17.5	22.5
Stope Strike Length	m	5.0	5.0	5.0	5.0	5.0
Ore Tonnes	t	2,279,334	550,668	1,472,146	558,640	432,342
Grade Nickel (Ni)	%	1.47	1.26	1.38	1.70	1.62
Grade Arsenic (As)	ppm	537	912	170	385	229

## Production Target Selection Process

After the completion of the MSO process, each individual 5m strike length stoping block was assessed in terms of:

- Location
- Proximity to Planned Development
- Proximity to other Potentially Economic Blocks
- Potential Revenue
- Assessed Geotechnical Parameters
- Mining Practicalities
- Mine Schedule
- Effect on Processing Feed and Concentrate Quality

Subsequently, a portion of the MSO material was converted into mineable inventory. MSO blocks were then combined into stope panels with a minimum strike length of 5m and a maximum of 30m. This is in accordance with the determined geotechnical hydraulic radius constraints. The majority of the stope panels, where possible, were 20m in strike length for most of the mines. All panels were then split into stoping and development shapes before then being incorporated into the mining schedule after application of mine recovery factors depending on mining method for each block as shown below.

**Table 18 - Additional Production Target Recovery Factors**

Mining Method	Min Width	Mining Recovery Factors	
		Tonnes	Grade
Ore Drive	4.5	100%	100%
L/H Pit Crown	1.5	85%	100%
L/H Top Down	1.5	85%	100%
L/H Up Blind	1.5	85%	100%
L/H to CRF Crown	1.5	85%	100%
L/H BU WRF	1.5	98%	100%
L/H BU CRF	1.5	98%	100%

- L/H- longhole
- CRF- cemented rock fill
- WRF- waste rock fill
- BU- bottom up

### Production Target

Table 19 below shows the estimated Production Target for the Project.

Outside of mining areas an existing stockpile from past mining at Armstrong has been included representing some 28,710t of material. This material has been assessed as amenable to processing and is deemed viable.

**Table 19 - Mt Edwards Nickel Operation Production Target**

PRODUCTION TARGET	Unit	WTS	GW3	ANM	132N	TOTAL
Ore Drive Tonnes	t	228,465	336,123	77,563	71,748	<b>713,899</b>
Stope Tonnes	t	1,494,327	1,999,924	467,902	342,794	<b>4,304,947</b>
Surface Ore Stocks	t	0	0	28,710	0	<b>28,710</b>
<b>TOTALS</b>						
Ore Tonnes	t	1,722,791	2,336,047	574,175	414,542	<b>5,047,556</b>
Grade Nickel (Ni)	%	1.66	1.46	1.66	1.60	<b>1.56</b>
Grade Copper (Cu)	ppm	2,138	1,646	1,280	1,221	<b>1,738</b>
Grade Cobalt (Co)	ppm	544	382	241	197	<b>406</b>
Grade Arsenic (As)	ppm	517	338	377	227	<b>394</b>
Grade Gold (Au)	ppm	0.07	0.08	0.17	0.20	<b>0.10</b>
Grade Palladium (Pd)	ppm	0.24	0.26	0.38	0.20	<b>0.26</b>
Grade Platinum (Pt)	ppm	0.11	0.12	0.19	0.10	<b>0.12</b>
Grade Iron (Fe)	%	14.79	11.27	8.24	10.73	<b>12.08</b>
Grade Magnesium Oxide (MgO)	%	20.72	24.75	26.91	15.14	<b>22.83</b>
Grade Sulphur (S)	%	6.48	3.82	2.18	1.91	<b>4.38</b>

## Mining Schedule

The proposed mining schedule is shown below, the schedule includes a proportion of Inferred Mineral Resources that cannot be used in the future classification of Ore Reserves. The Company has re-estimated 4 of the 6 Resources subjected to drilling. Further drilling may ultimately be warranted to either extend mineralisation or convert further mineralisation from inferred to indicated for the purposes of declaring a maiden mining reserve.

The Scoping Study schedule has been driven in part, by ore classification, in order to be able to ensure the early years in the proposed mine life are dominated by high confidence “Indicated” material as shown by the underlying graph.

The first four years of ore production from the mines has a split of Measured and Indicated versus Inferred of greater than 83% in the higher confidence indicated category.

Overall life of mine 77% of ore tonnes mined come from higher confidence Indicated category.

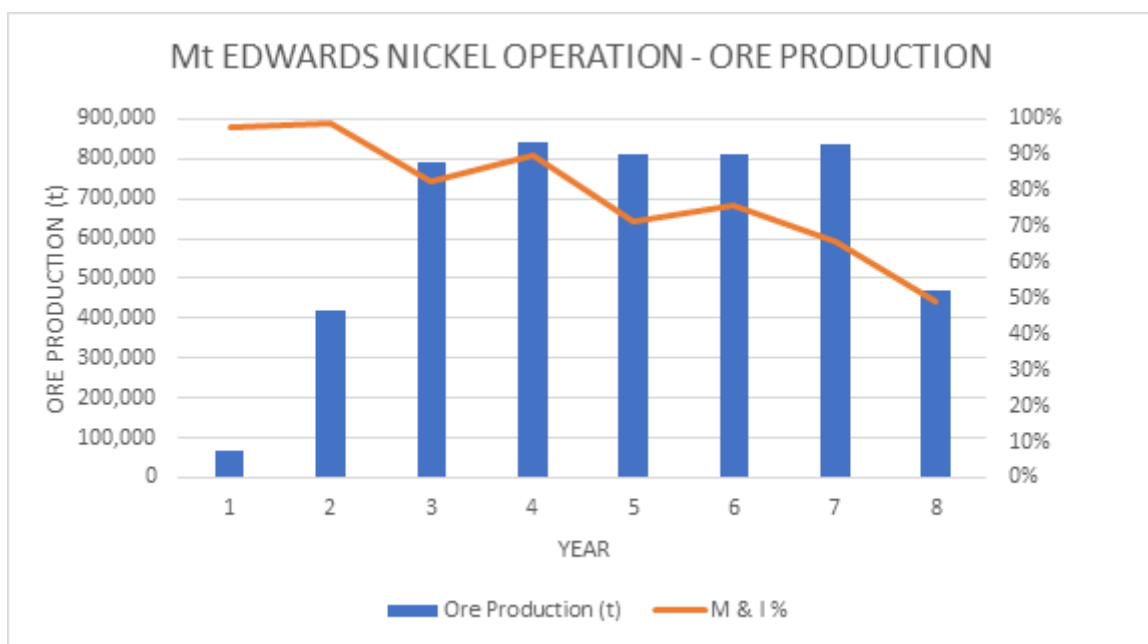

**Figure 20 - Mining Material Classification Production Graph**

Key limitations driving the schedule and underlying manning and equipment for the schedule are as follows:

- Maximum Main Decline Advancement rate per month = 180m
- Maximum Total Jumbo Rig Advancement rate per month = 300m
- Maximum Jumbo Drill Rig Drill Metres per month = 30,000DRM
- Maximum Production Rig Drill Meters per month = 6,500DRM
- Maximum Ore Stope Bog (per loader) per month = 30,500t
- Maximum Total Back Fill (per loader) placed per month = 30,000t
- Maximum CRF Fill placed per month = 20,000t
- Maximum tkm per truck per month = 65,000tkm

**Table 20 - Underground Mining Production Schedule**

YEAR	Year 1	Year 2	Year 3	Year 4	Year 5	Year 6	Year 7	Year 8	TOTAL
<b>Total Mine Production</b>									
Total Ore Tonnes (t)	65,878	418,430	792,540	839,484	813,571	812,116	834,745	470,792	<b>5,047,556</b>
Ore Grade Ni (%)	1.28	1.55	1.48	1.55	1.51	1.67	1.64	1.54	<b>1.56</b>
Ore Grade Cu (ppm)	1,387	1725	1708	1906	1840	1829	1633	1398	<b>1738</b>
Ore Grade Co (ppm)	346	448	396	446	451	433	354	287	<b>406</b>
Ore Grade As (ppm)	653	797	606	258	284	432	303	172	<b>394</b>
Ore Grade Au (ppm)	0.04	0.10	0.09	0.07	0.07	0.10	0.13	0.13	<b>0.10</b>
Ore Grade Pd (ppm)	0.16	0.29	0.32	0.26	0.21	0.27	0.28	0.22	<b>0.26</b>
Ore Grade Pt (ppm)	0.07	0.14	0.14	0.12	0.11	0.13	0.13	0.10	<b>0.12</b>
Ore Grade Fe (%)	10.83	12.24	12.10	12.77	13.05	12.14	11.14	10.76	<b>12.08</b>
Ore Grade MgO (%)	21.80	19.89	20.75	23.26	24.09	24.71	23.85	21.12	<b>22.83</b>
Ore Grade Sulphur (%)	4.18	4.94	4.33	5.10	5.18	4.57	3.46	2.66	<b>4.38</b>
Fe/MgO Ratio	0.50	0.62	0.58	0.55	0.54	0.49	0.47	0.51	<b>0.59</b>
Ni/Sulphur Ratio	0.31	0.31	0.34	0.30	0.29	0.37	0.47	0.58	<b>0.39</b>
Ore Contained Ni (t)	845	6,467	11,747	12,978	12,284	13,599	13,677	7,244	<b>78,840</b>
Ore Contained Cu (t)	91	722	1,354	1,600	1,497	1,485	1,363	658	<b>8,770</b>
Ore Contained Co (t)	23	187	314	374	367	352	296	135	<b>2,048</b>
Ore Contained As (t)	43	334	480	216	231	351	253	81	<b>1,989</b>
Ore Contained Au (oz)	86	1,321	2,382	2,015	1,818	2,617	3,532	1,965	<b>15,737</b>
Ore Contained Pd (oz)	338	3,905	8,215	6,968	5,434	7,122	7,485	3,287	<b>42,754</b>
Ore Contained Pt (oz)	159	1,890	3,500	3,206	2,789	3,486	3,561	1,563	<b>20,155</b>
Ore Contained Fe (t)	7,137	51,197	95,936	107,201	106,156	98,630	93,003	50,664	<b>609,923</b>
Ore Contained MgO (t)	14,359	83,217	164,429	195,251	195,949	200,697	199,054	99,446	<b>1,152,402</b>
Ore Contained Sulphur (t)	2,756	20,682	34,329	42,831	42,172	37,129	28,873	12,525	<b>221,297</b>
<b>Classification Ratios</b>									
Measured & Indicated (t)	64,448	413,129	654,263	755,899	580,378	617,254	551,285	231,101	<b>3,867,757</b>
Inferred (t)	1,431	5,301	138,277	83,584	233,193	194,862	283,459	239,692	<b>1,179,799</b>
M & I %	<b>98%</b>	<b>99%</b>	<b>83%</b>	<b>90%</b>	<b>71%</b>	<b>76%</b>	<b>66%</b>	<b>49%</b>	<b>77%</b>

**Cautionary Note**

*There is a low level of geological confidence associated with Inferred mineral Resources and there is no certainty that further exploration work will result in the determination of Indicated mineral Resources or that the production target itself will be realised*

The mining operations commence at both Widgie Townsite (WTS) and Gillett & Widgie 3 (GW3) with these 2 mines the focus of the operation for the first 4 years. Mine development at Armstrong is scheduled to commence in year 5 with the 132N development planned for the end of year 5.

A summary of the mine physical schedules is provided in Table 21. Full production from the mines (70kt per month) is reached in month 27 with the planned completion of the process plant construction

month 15. The current schedule provides a 120kt Run of Mine (ROM) stockpile prior to the commencement of ore processing, which provides an adequate buffer and for blending ore mill feed.

From the current Production Target, full operation mine production can be achieved for 6 years. Additional to this, but not considered as part of this Scoping Study, there are a further 7 defined Mineral Resources containing 5.37Mt grading 1.44% Ni for 77.2kt of contained nickel located in the Mt Edwards Project that can ultimately be exploited.

**Table 21 - Individual Mine Physical Schedule Summary**

YEAR	Year 1	Year 2	Year 3	Year 4	Year 5	Year 6	Year 7	Year 8	Total
<b>Widgie Townsite (WTS)</b>									
Total Ore Tonnes (t)	26,761	265,752	364,987	359,999	341,999	225,686	137,606	0	<b>1,722,791</b>
Ore Grade Ni (%)	1.42	1.64	1.53	1.72	1.67	1.78	1.71	0	<b>1.66</b>
Total Jumbo Dev (m)	2,827	3,553	2,533	2,495	1,458	0	0	0	<b>12,865</b>
Main Haulageway Dev (m)	1,569	595	551	911	79	0	0	0	<b>3,706</b>
Waste Fill (t)	0	70,025	156,077	197,388	123,927	128,398	32,905	0	<b>708,720</b>
Cement Fill (t)	0	71,582	87,268	74,092	32,755	46,048	0	0	<b>311,745</b>
Total Tucking (tkm)	237,744	698,913	1,068,000	1,482,841	1,439,180	1,245,702	541,690	0	<b>6,714,069</b>
<b>Gillett &amp; Widgie 3 (GW3)</b>									
Total Ore Tonnes (t)	10,407	152,678	427,553	479,485	460,922	368,277	252,000	184,726	<b>2,336,047</b>
Ore Grade Ni (%)	1.34	1.38	1.44	1.42	1.38	1.51	1.71	1.44	<b>1.46</b>
Total Jumbo Dev (m)	5,753	8,431	7,259	3,432	859	0	0	0	<b>25,733</b>
Main Haulageway Dev (m)	2,940	4,013	1,106	0	0	0	0	0	<b>8,060</b>
Waste Fill (t)	0	67,317	168,070	185,323	211,814	261,382	205,974	133,260	<b>1,233,141</b>
Cement Fill (t)	0	37,081	74,880	31,223	86,669	33,555	0	0	<b>263,408</b>
Total Tucking (tkm)	515,378	1,478,138	1,829,629	1,393,802	1,440,604	1,393,075	889,854	593,584	<b>9,534,064</b>
<b>Armstrong (ANM)</b>									
Total Ore Tonnes (t)	28,710	0	0	0	10,650	218,153	270,288	46,374	<b>574,175</b>
Ore Grade Ni (%)	1.13	0	0	0	1.87	1.84	1.56	1.62	<b>1.66</b>
Total Jumbo Dev (m)	0	0	0	0	2,843	1,567	312	0	<b>4,722</b>
Main Haulageway Dev (m)	0	0	0	0	1,318	128	0	0	<b>1,446</b>
Waste Fill (t)	0	0	0	0	0	71,208	143,494	0	<b>214,702</b>
Cement Fill (t)	0	0	0	0	0	54,471	17,538	223	<b>72,232</b>
Total Tucking (tkm)	0	0	0	0	244,619	510,737	512,807	79,850	<b>1,348,013</b>
<b>132N (132N)</b>									
Total Ore Tonnes (t)	0	0	0	0	0	0	174,850	239,692	<b>414,542</b>
Ore Grade Ni (%)	0	0	0	0	0	0	1.60	1.60	<b>1.60</b>
Total Jumbo Dev (m)	0	0	0	0	344	2,724	2,064	281	<b>5,413</b>
Main Haulageway Dev (m)	0	0	0	0	253	1,527	244	0	<b>2,024</b>
Waste Fill (t)	0	0	0	0	0	0	77,567	158,053	<b>235,620</b>
Cement Fill (t)	0	0	0	0	0	0	20,643	0	<b>20,643</b>
Total Tucking (tkm)	0	0	0	0	13,144	306,419	628,334	627,578	<b>1,575,474</b>



TOTALS									
Total Ore Tonnes (t)	65,878	418,430	792,540	839,484	813,571	812,116	834,744	470,792	5,047,555
Ore Grade Ni (%)	1.28	1.55	1.48	1.55	1.51	1.67	1.64	1.54	1.56
Total Jumbo Dev (m)	8,579	11,984	9,792	5,927	5,504	4,291	2,376	281	48,734
Main Haulageway Dev (m)	4,509	4,608	1,658	911	1,651	1,655	244	0	15,235
Waste Fill (t)	0	137,342	324,148	382,711	335,740	460,988	459,941	291,313	2,392,183
Cement Fill (t)	0	108,664	162,148	105,315	119,424	134,073	38,181	223	668,027
Total Tucking (tkm)	753,122	2,177,051	2,897,628	2,876,643	3,137,547	3,455,933	2,572,685	1,301,011	19,171,620

## Mining Schedule Description

The underlying strategy for the mine schedule is to develop the WTS, Widgie 3 and Gillett Mineral Resources to ramp the ore production rate up to 800ktpa as quickly as possible (Figure 21). The main source of early production is scheduled from the WTS Mineral Resource. WTS Stage 1 production starts at the 150mRL (4L to 1L). A production rate over 34kt per month is planned from WTS from month 19.

It is also necessary to balance the nickel/sulphur ratio in the mill feed to enable a consistent 10.1% concentrate grade to be produced. The Widgie 3 deposit has the highest nickel/sulphur ratio of all the Mineral Resources and is subsequently also scheduled for early mine production. Stage 1 of Widgie 3 starts at the 205mRL (4L to 2L) is quick to access and can provide a production rate of up to 20kt per month from month 15.

The Gillett Mineral Resource is deeper with the Stage 1 production starting at the 95mRL (5L to 1L). It is scheduled to achieve full production of 35kt per month in month 39. This mineral Resource also has a greater proportion of lateral development required to be completed prior to stoping thus delaying the commencement of production.

After month 38, the Widgie 3 Resource begins to quickly deplete just as WTS and Gillett are in full production. Month 49 sees commencement of Armstrong with full production commencing in month 65 at a rate of 23kt as WTS slows in production to 20kt. GW3 also winds down to 20kt in month 72 leading to the required commencement of 132N production. As a result this mine development commences in month 59 to allow ramp up and ensure the Project operates at full production for the last 2 years.

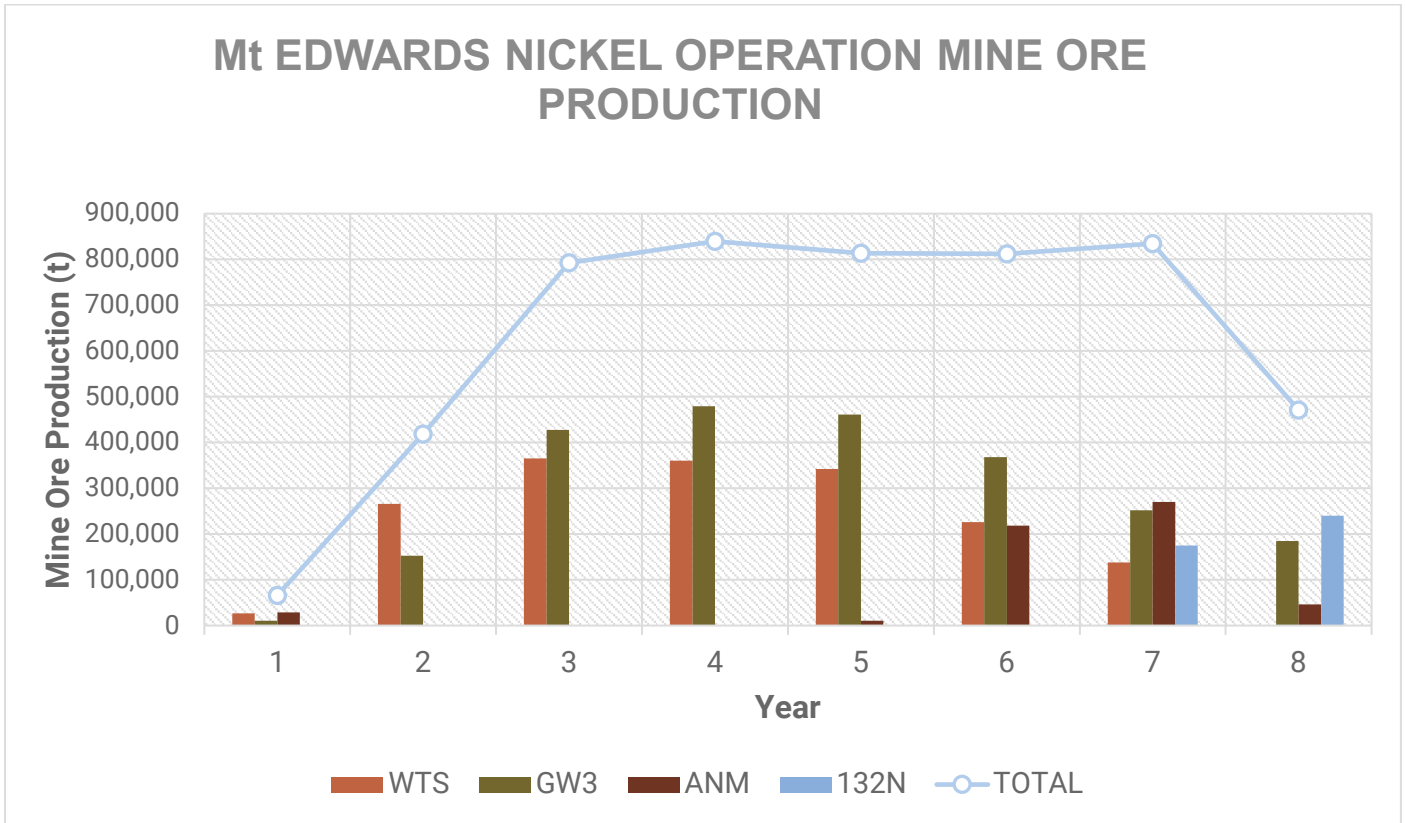

Figure 21 -Mt Edwards Annual Mine Production Graph

## Metallurgy and Processing

### Metallurgical Testwork

Historic metallurgical testwork on various composite samples from the main nickel deposits at Widgiemooltha has been reported between 2005 and 2013. A more comprehensive testwork program using diamond core samples is currently being executed by Widgie on selected mineralisation from the deposits that support the Scoping Study and others (Gillett, WTS, Widgie 3, 132N and Munda). Testing on diamond core samples from Armstrong has been completed earlier (2022-2023) exploring early mining and potential toll treatment options by various existing nickel concentrators in the district.

The current metallurgical program is being carried out by Auralia Metallurgy in Midvale, Perth, Western Australia with chemical analysis and certain components of testing, such as XRD and Davis Tube Washing (DTW), by ALS Metallurgy located in Balcatta, Perth, Western Australia.

The 2023 bench scale testing program has been designed to test a weighting of at least 32 fresh rock variability samples to generally align to the processing inventory adopted for the Scoping Study. Each variability sample is a discrete continuous core interval and selected to provide at least a range of nickel grades within each deposit. Other selection criteria included nickel to sulphur and arsenic to nickel ratios where appropriate. The testing of mineralisation from each deposit is considered justified at this stage noting variance in the average Resource ratios of nickel to sulphur, arsenic, gold, palladium, and platinum to ultimately support process definition for a higher level of study (PFS or DFS).

## Mineralogy

In 2022, four (4) composite samples of variable nickel grade from the Armstrong deposit were provided to ALS for semi-quantitative XRD analysis. The major sulphide minerals identified were pentlandite ((Fe,Ni)<sub>9</sub>S<sub>8</sub>), and pyrite (FeS<sub>2</sub>). The most prevalent silicate minerals were clinocllore ((Mg,Fe)<sub>5</sub>Al(Si<sub>3</sub>Al)O<sub>10</sub>(OH)<sub>8</sub>), amphiboles and serpentine (Mg<sub>3</sub>Si<sub>2</sub>O<sub>5</sub>(OH)<sub>4</sub>).

Although no arsenic minerals were identified in XRD analysis of the core samples alone, 21% by mass of Nickeline (NiAs) was identified in concentrate from a master composite (even blend of Composites 1 to 4) generated by a series of separation techniques at feed size of P<sub>80</sub> 150µm: Knelson gravity, magnetic, and panning. Nickeline reported to the Knelson concentrator, non-magnetic pan concentrate stream with nickel and arsenic grades of 19.2% and 6.8% respectively. This small mass stream represented 0.3% of feed mass and contained 3.3% and 41.2% of feed nickel and arsenic respectively.

Historic testwork from 2013 (MIN1464) on a sample of unknown origin detected sulphide minerals pentlandite ((Fe,Ni)<sub>9</sub>S<sub>8</sub>), pyrite (FeS<sub>2</sub>), chalcopyrite (CuFeS<sub>2</sub>), and pyrrhotite (Fe<sub>(0.8-1.0)</sub>S). Gangue silicate minerals included calcic amphiboles, talc (Mg<sub>3</sub>Si<sub>4</sub>O<sub>10</sub>(OH)<sub>2</sub>) and serpentine. Nickeline (NiAs) was detected at trace level (0.1%).

Further mineralogy work is planned to better characterise mineralisation from all the Widgie deposits. The preliminary work on Armstrong indicates:

- Pentlandite is the dominant nickel sulphide mineral and the risk of significant nickel grade dilution by pyrite in a sulphide flotation concentrate is therefore low.
- Clinocllore, amphiboles and serpentine make up the majority of gangue minerals.
- Some talc is detectable (1-2%) and may be more problematic to sulphide flotation where the sulphide content / concentrate mass yield is low.
- A moderate amount of Magnetite (Fe<sub>3</sub>O<sub>4</sub>) exists (4-9%) which may offer opportunity for improving the iron to magnesium ratio of concentrate.
- Where arsenic grade is high nickeline has been detected. The high SG of this mineral (SG -7.8) may enable concentration by gravity to control arsenic levels in the nickel sulphide concentrate.

## Comminution Testwork

Results have been received for 16 composite samples (four Armstrong, four Gillett, two Widgie Townsite, three Widgie 3, two 132N, and one Munda) as shown in Table 61. The Armstrong and Munda samples have very high rock competency (SCSE 11.3 to 13.4 kWh/t) and moderate to high ball mill energy demand (Armstrong average Bond BWi 20.3 kWh/t, Munda Bond BWi 22.7 kWh/t). The Gillett and Widgie Townsite samples are of moderate competency (SCSE 7.3 to 10.54 kWh/t) and so are more typical of Wood's database of similar Western Australian komatiitic nickel sulphide deposits from the Eastern Goldfields. The ball mill energy demand for Gillett and Widgie Townsite samples is low with the Widgie 3 samples considered low to moderate.

**Table 22 - Comminution Data Summary**

Sample	Bond Ball Mill Work Index, # 75µm (kWh/t)	SMC SG	Drop Weight Index, DWi (kWh/m <sup>3</sup> )	Axb	SCSE (kWh/t)
ARM Comp 1 MEDD037_267-284m	20.70	2.90	8.60	33.50	11.27
ARM Comp 2 MEDD038_260 - 276m	17.90	3.03	9.10	33.30	11.66
ARM Comp 3 MEDD036_190-205m	22.10	2.86	9.30	30.50	11.70
ARM Comp 4 MEDD034_180-212.2m	20.70	2.97	11.80	25.10	13.38
GIL Comp 5 MERC143_241.8-254.0m	N/A	3.12	4.00	78.80	7.86
GIL Comp 6 MERC148_341.2-351.4m	N/A	3.10	6.20	50.70	9.57
GIL Comp 7 MERC183_234.0-242.0m	N/A	3.35	4.00	84.00	7.70
GIL Comp 8 MERC193_237.0-253.0m	N/A	3.36	3.50	95.30	7.30
WT Comp 1 MEDD064_405-412m	9.56	3.17	7.50	42.40	10.54
WT Comp 5 23MERC039_510.5-420.8m	8.61	3.24	5.00	65.20	8.61
W3 Comp 1	13.30				
W3 Comp 3	12.80				
W3 Comp 8	14.80				
132N Comp 1	11.10				
132N Comp 2	9.82				
Munda Comp 2	22.70				

Given the significantly higher rock competency and ball mill energy demand indicated for Armstrong and Munda mineralisation this aspect has the potential to become an important factor in considering the final comminution circuit design, blending practices and predictions of process performance and unit operating cost. The mine schedule adopted for the Scoping Study incorporates a maximum 20kt/m of Armstrong feed in the latter third so is less problematic in this regard.

### Sulphide Flotation Testwork

To date, bench scale flotation and other testwork has been completed on samples from the Armstrong deposit, with work on Gillett and WTS ongoing. Composite samples from all three deposits have undergone tests using a basic open circuit flowsheet (standard flowsheet) as shown in Figure 22 below.

The flowsheet comprises of four stages of roughing, a scavenger stage, and four stage cleaning of the combined rougher concentrates. There is also conditioning stages where the collector (sodium ethyl xanthate), activator (copper sulphate), depressant (guar) and frother are added prior to flotation.

The composite samples were ground down to a  $P_{80}$  of 53 $\mu$ m in consideration of prior work on the Armstrong mineralisation and the general fine-grained nature of the Widgiemooltha sulphides. The scavenger tails, scavenger concentrate, cleaner tails and all four cleaner concentrate streams were individually analysed for at least Ni, Fe, S, MgO, SiO<sub>2</sub>, As, CaO, Al<sub>2</sub>O<sub>3</sub>, Co and Cu.

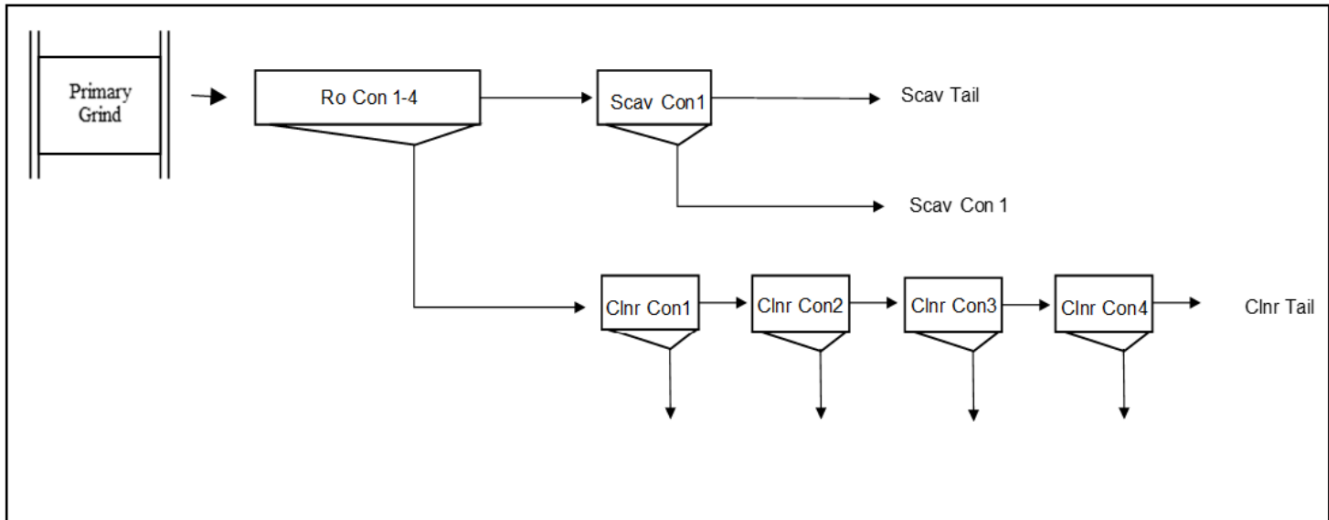

**Figure 22 - Standard Benchscale Flotation Test Flowsheet**

Across the flotation variability tests the dose rate for copper sulphate, xanthate and guar in the rougher conditioning and cleaner conditioning tanks were kept constant.

### Armstrong Standard Flotation Flowsheet Tests

Results for testing the standard flotation scheme are shown in Table 23. The data highlights a strong relationship between nickel head grade and nickel recovery and high arsenic in feed propagating through to high arsenic in concentrate.

**Table 23 - Armstrong Standard Flotation Flowsheet Results**

Armstrong Standard Flotation Flowsheet Results					
	Composite 1	Composite 2	Composite 3	Composite 4	
Head Ni Grade (%)	3.68	1.17	1.74	0.53	
Head S Grade (%)	5.00	1.25	2.14	0.72	
Head As Grade (ppm)	0.02	0.02	0.17	0.06	
Concentrate Ni Grade (%)	10.30	4.30	4.39	2.29	
(Ro Con + Scav Con)					
Ni % Recovery	93.70	79.10	89.30	70.30	
(Ro Con + Scav Con)					
Combined Cleaner Concentrate 1-4	Ni % Recovery	89.80	72.20	83.20	61.80
	Ni Grade (%)	17.00	12.60	10.50	6.99
	S Grade (%)	22.90	16.00	13.30	11.80
	Cu Grade (%)	0.80	1.00	1.00	0.50
	Pd Grade (ppm)	2.70	3.40	2.80	1.30
	MgO Grade (%)	11.30	17.50	18.50	19.20
	As Grade (ppm)	737	991	8935	5073

The Armstrong samples were used for more detailed testwork to support potential toll treatment prior to a transition in Q2 2023 to study a standalone greenfield concentrator at Widgiemooltha. The key learnings of this work include:

- Arsenic minerals are fast floating and report to the front of the cleaners.
- Magnesium silicates are difficult to depress and so impact the concentrate quality.
- The Armstrong mineralisation has a high Ni:S (0.7 – 0.9) which is favourable and tends to carry through to the concentrate.
- A component of nickel is slow floating and recovered in the scavengers where the depression of magnesium silicates is more difficult.
- The higher the nickel head grade the easier to achieve high nickel recovery and clean concentrate.
- Palladium in the combined cleaner concentrate and gold in the first cleaner concentrate are above minimum payable quantities as indicated under terms (1g/t).
- Knelson gravity separation upstream of the flotation circuit resulted in reduced arsenic recovery in the flotation concentrate.
- Magnetic concentrate was recoverable from the scavenger tails of all samples. A clean combined concentrate of 56.7% Fe, 1.3% Ni, 7.5% MgO and 2.0% S was generated, which could be potentially used to improve nickel recovery and the iron to magnesium ratio of the sulphide concentrate.

## Gillett Standard Flotation Flowsheet Tests

Ten (10) composite samples from the Gillett (**GIL**) deposit were used for flotation tests using the standard flotation scheme.

In line with average Resource chemistry, the GIL composites all had head nickel to sulphur ratios in the 0.28-0.33 range while the Armstrong (**ANM**) composites were 0.72-0.93. The GIL mineralisation therefore carries more sulphide sulphur assumed as pyrite ( $\text{FeS}_2$ ). Stoichiometrically, the GIL ratio is equivalent to 41 to 47% pentlandite in a binary pentlandite/pyrite mixture. The ANM ratio is equivalent to 84 to 99% pentlandite.

The key learnings from the standard flotation tests on GIL samples include:

- MgO recovery was minimal across the first two cleaners (duration of 3 minutes), increasing in the final two cleaners (duration 6 minutes).
- Lower sulphur and nickel head grade samples were generally more difficult to float with significant magnesium and silica diluting the cleaner concentrates.
- Typically, the highest concentrate nickel grade was seen in the concentrate from the first cleaner except where copper grades were greater than 5% and so dilutionary to the nickel grade.
- Arsenic grade was elevated in only two of the composite samples and like the ANM tests strongly reports to the front of the cleaners.
- Cobalt, copper, palladium, gold in the first cleaner concentrate are commonly above the minimum payable indicated by trader terms (0.3%, 3% and 1g/t respectively).
- Sulphur recovery is consistently less than nickel indicating a low nickel sulphur mineral is not being effectively recovered by the standard flotation scheme. However, this phenomenon is advantageous in lifting the nickel grade of the Gillett concentrates.

## Widgie Townsite Standard Flotation Flowsheet Tests

Standard flotation scheme results of four composite samples from the WTS deposit were available at the time of reporting.

The WTS composites had head nickel to sulphur ratios similar to those for Gillett in the 0.25 - 0.32 range, with Composite 6 an outlier at 0.10. The sulphur recovery and sulphur grade in the concentrate were comparable with that reported for Gillett. Cobalt and copper in the first cleaner concentrate are commonly above the minimum payable indicated by metal traders (0.3%, 3% respectively).

Composite 6 (AM215-6) was the outlier of the set, with lower head grades for nickel (0.9%) and MgO (12.5%). While nickel recovery was high (81.8% to C1-4), the combined cleaner concentrate nickel grade was low (5.4%) and limited in this case by iron and sulphur rather than magnesium and silica.

## Flotation Testwork Summary

The variability testing thus far has shown that the flotation behaviour of the Widgiemooltha nickel mineralisation is variable between deposits and that some properties such as nickel grade and nickel to sulphur ratio may become important blending controls. Standard flotation and scavenger tail magnetic separation test results from samples across all the main deposits will require collective analysis and evaluation to better frame an optimal mining and processing sequence to support design criteria for a customised process flowsheet.

Opportunity for generating nickel concentrates payable for palladium, cobalt, copper and gold is indicated from this preliminary work.

At this stage the primary nickel sulphide concentrate contaminants that could invoke penalties are recognised as magnesium and arsenic. Pending return of results for the outstanding variability tests separate scavenger concentrate cleaning and or closed circuit recleaning could be introduced to the flowsheet to lower magnesium in concentrate. Arsenic is known to be sporadically distributed in the nickel mineralisation of some Widgiemooltha deposits and small intervals of very high grade (>2% As) exist in the drill hole database. Given this nature of occurrence it may well prove too difficult and costly to quantify and effectively blend arsenic into process feed. Either a concentrate blending operation post processing or a process that better rejects or separately concentrates arsenic minerals (e.g., by gravity) may be required.

A comparison summary of the average combined cleaner concentrate results for each deposit is presented in Table 24.

**Table 24 - Average Combined Cleaner Concentrate (C1-C4) Results**

AVERAGE COMBINED CLEANER CONCENTRATE (C1 - C4) RESULTS					
Deposit	Number of Standard Flowsheet Tests Reported	Nickel Recovery (%)	Nickel Grade (%)	MgO Grade (%)	Ni:S Feed / Ni:S Concentrate
Armstrong	4	61.8 - 89.8	6.99 - 17.0	11.3 – 19.2	1.04
		(Average 76.7)	(Average 11.8)	(Average 15.3)	
Gillett	10	65.7 - 82.1	3.68 - 17.3	1.20 – 22.7	0.70
		(Average 72.5)	(Average 9.95)	(Average 11.9)	
Widgie Townsite	6	66.2 - 81.8	4.50 - 15.7	1.26 – 20.2	0.69
		(Average 72.2)	(Average 10.9)	(Average 7.28)	
Widgie 3	8	28.3 - 85.1	1.81 - 20.5	2.48 - 27.8	1.08
		(Average 50.9)	(Average 9.54)	(Average 17.6)	

On average, the GIL, WT, and W3 composites did not achieve as high a nickel recovery or nickel grade from the cleaners compared to the Armstrong samples. Further diagnostic investigation is underway to better understand why W3 samples did not respond well to the standard open circuit flowsheet test.

### Process Flowsheet

A blend of ROM ore, sized minus 600 mm is crushed through a three-stage mobile crushing circuit at a rate of 220 t/h. The crushed ore product passes a 10 mm aperture closing screen and is stored in a fine ore bin or transported by front end loader (FEL) to emergency stockpiles.

Not shown in the flowsheet schematic is a provision for the crushing circuit to campaign crush and produce up to 30 kt/a of stemming fill for use underground or for other crushed construction rock demand.

The fine ore from the fine ore storage bin or emergency stockpiles is fed to the ball mill along with the recycling cyclone underflow and water to achieve the correct milling slurry density. The ball mill discharge is diluted with water, dosed with copper sulphate (activator), and fed to a pack of hydrocyclones which classify the solids to maintain a P<sub>80</sub> of 53 µm in the overflow. The underflow is returned to the ball mill for further size reduction.

The cyclone overflow is collected in a surge tank and pumped to conditioning tanks for dosing with xanthate (collector) and guar gum (depressant) before the addition of frother and introduction to the rougher and scavenger cells. The concentrate from the rougher and scavenger cells is collected and pumped through cleaner conditioning tanks for dosing copper sulphate, xanthate and guar gum before being fed to the cleaner flotation circuit. Frother is added at various points within the flotation circuit.

The combined tails from the scavenger and cleaner cells are dewatered by a tails thickener. The slurry is dosed with flocculant, thickened, then pumped to a tailings storage facility (TSF). The overflow from the tails thickener and decant from the TSF are returned to the process water tank.

The concentrate from the cleaner cells is dewatered by a concentrate thickener and pressure filter. The concentrate slurry is dosed with flocculant, thickened, filtered, and conveyed as a damp cake to the concentrate storage shed. The concentrate thickener overflow is returned to the process water tank. The filtrate is circulated back to the concentrate thickener. The pressure filter uses reverse osmosis (RO) permeate as wash water to lower chloride levels in the concentrate and rinse the filter cloths. A filter wash ratio of 0.2 m<sup>3</sup>/t of concentrate has been assumed.



Raw water for the process is assumed to be 40,000 total dissolved solids (TDS) and supplied from an existing borefield nearby.

A provision for two months storage of concentrate for grading and outbound blending of magnesium and arsenic has been allowed for within the concentrate storage shed. Road trains are assumed to transfer concentrate 290 km to a storage and rotainer transfer shed at the Port of Esperance.

A Widgie owned and operated assay laboratory with XRF and fire assay capability has been allowed for on-site.

Figure 23

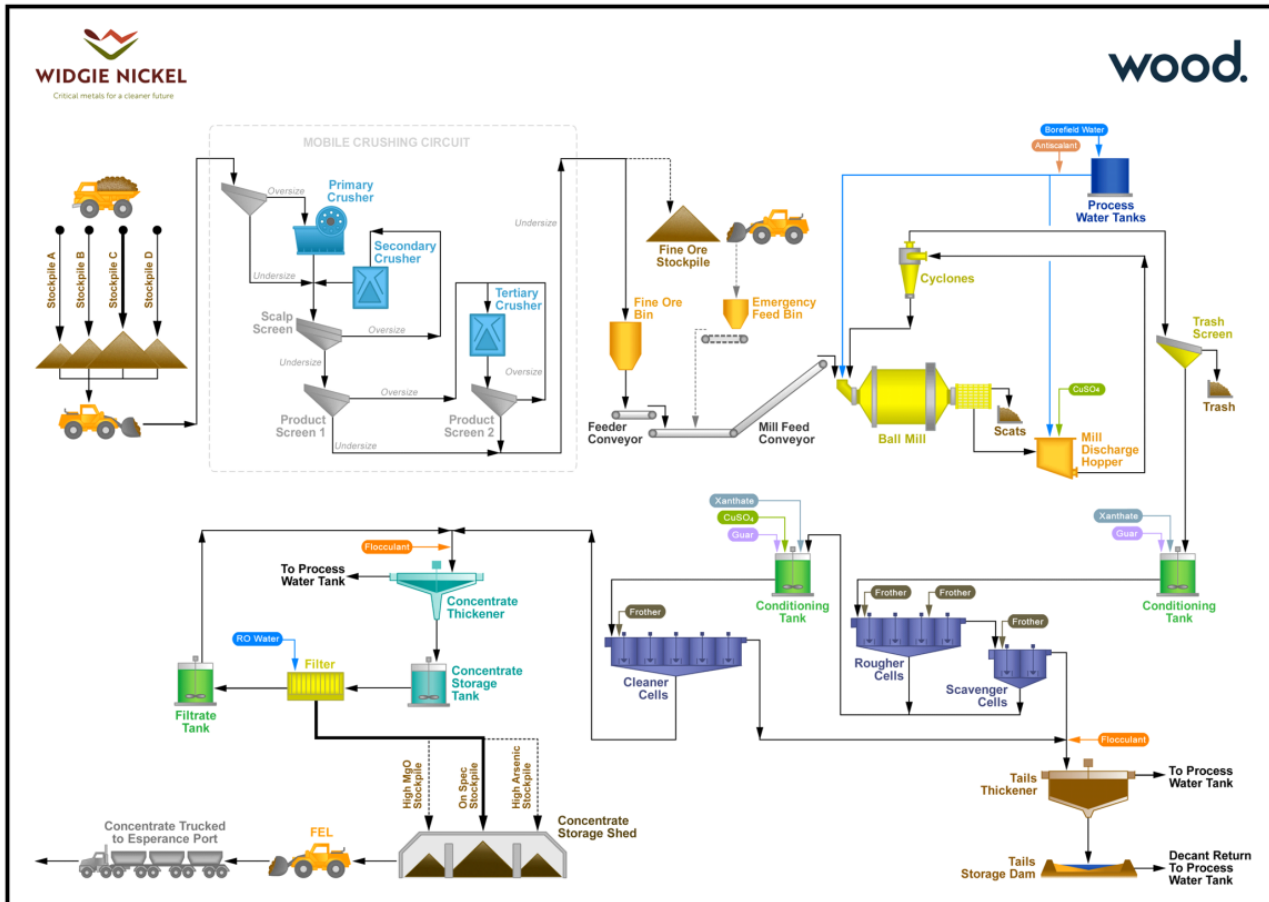

Figure 23 - Mt Edwards Nickel Concentrator Flowsheet Schematic

## Plant Design

The process flowsheet and associated preliminary mass balance was developed based on treating 800ktpa of blended underground ores from the Mt Edwards Project, limited available testwork information and where necessary Wood’s database information and or experience in design of similar concentrators.

## Major Plant Equipment

The major equipment sized for the proposed flowsheet are described at high level below in Table 25.

**Table 25- Major Process Plant Equipment**

Equipment	Description	Size	No. of Units
Three stage crushing circuit	Mobile Jaw Crusher, LT130E	220 t/h total throughput, to -10mm size	1
	Mobile Cone Crusher, LT3000HP	Jaw crusher installed power 185 kW	2
	Mobile Screen, ST3.8	Cone crusher installed power 225 kW Screen size 1.3m x 3.0m	2
Fine Ore Bin	14 hours residence time, live capacity	725 m <sup>3</sup>	1
Ball Mill		15' Ø, 26.2' EGL 3.2 MW installed power	1
Cyclones	Hydrocyclone	250mm diameter	8 (6 duty, 2 standby)
Flotation and Scavenger flotation cells		30 m <sup>3</sup> cells (total 180m <sup>3</sup> )	6 (4 rougher, 2 scavenger)
Cleaner flotation cells		20 m <sup>3</sup> cells (total 100 m <sup>3</sup> )	5
Concentrate Thickener	Conventional above ground thickener	8m diameter	1
Concentrate Pressure Filter	Larox PF60 or equivalent	84 m <sup>2</sup> filtration area, 14 plates	1
Tails Thickener	Conventional above ground thickener	13m diameter	1
Xanthate Tank	Make-up 25wt% solution from 1t bags	4.5 m <sup>3</sup> tank	1
CuSO <sub>4</sub> Tank	Make-up 5wt% solution from 1t bags	22 m <sup>3</sup> tank	1
RO Plant	Reverse Osmosis Desalination	250 m <sup>3</sup> /day	1

## Concentrate Grade and Recovery

Concentrator recoveries and concentrate grades have been calculated from process feed attributes within the mine schedule based on predictive equations referencing cleaner 1 to 4 combined concentrate results from the variability testwork and or the following assumptions:

- 50% of the cleaner tail and scavenger concentrate units in the open circuit standard flowsheet tests are recovered to final concentrate at 0.9 x the C1-4 grade for Ni, Co, Cu, Pd, Au, Pt, S and As, and 1.1 x for gangue related analytes (e.g., MgO).
- That the W3 and 132N material will perform as per the tested ARM material when optimised.

The predicted life of mine average process feed grades and their associated forecasts are listed in Table 26.

**Table 26 - Concentrator Grade and Recovery Estimates (LOM Averages)**

Concentrate Grade and Recovery Forecasts (LOM Averages)			
Element	Feed Grade	Concentrator Recovery	Concentrate Grade
Ni	1.56%	79%	10.10%
Cu	1 738 ppm	93%	13 226 ppm
Co	406 ppm	76%	2 524 ppm
As	394 ppm	84%	2 709 ppm
Pd	0.26 ppm	76%	1.64 ppm
Pt	0.12 ppm	44%	0.45 ppm
Au	0.10 ppm	74%	0.59 ppm
Fe	12.10%	26%	25.70%
MgO	22.80%	7%	13.10%
S	4.38%	58%	20.80%

**Process Flow Sheet Concept**

A relatively simple concentrator flowsheet with one stage of grinding and open circuit flotation has been applied to support the Scoping Study. It is expected that both the mine schedule and process flowsheet will evolve when all the variability testwork results become available. Key objectives of the flowsheet will be to manage and minimise both magnesium and arsenic grade in concentrate whilst maintaining high nickel recovery. A secondary aim where practical will be generating nickel concentrates payable for palladium, cobalt, copper and gold.

For this 220dt/h day shift only duty, a semi mobile crushing circuit requires two independent double deck closing screens adding conveyors and complexity to the circuit. The screens are 1.3m wide by 3.0m long and at the largest size of typical vendor offerings. In future study work, it is recommended a permanent double deck screen installation is compared to simplify the circuit and layout.

A reasonable body of comminution variability testwork has been acquired thus far to support preliminary selection and sizing of the grinding circuit. Both Armstrong and Munda mineralisation is indicated to be significantly more competent and harder to grind within a ball mill compared to the other deposits. Managing the blending of these feed sources into the concentrator will enable design of a more economical comminution circuit. A slight relaxation of the primary grind size may be another opportunity to reduce the comminution specific energy demand.

Minimising magnesium silicates reporting to concentrate is a challenge for the base flowsheet and particularly with low sulphide content in the feed. Additional cleaning stages may ultimately be required and given the fine nature of the separation alternative flotation devices such as columns, Concorde or Imhoflot™ cell technology may find application. A more novel approach would be to carry out a fine gravity separation to reject a large majority of magnesium silicates prior to flotation. This concept is currently being trialled at ALS Metallurgy.

There is opportunity identified to add a low intensity magnetic recovery circuit to the flowsheet to recover additional nickel units, either to (1) dilute magnesium in the sulphide concentrate, (2) market separately, or (3) further process an iron sulphide concentrate. The third option could follow a roasting path in which value for the sulphide content may be realised from the recovery of sulphuric acid.

At this stage of study, the average predicted arsenic grade in concentrate over the life of mine is approximately half of the 5,000 ppm maximum threshold limit typically applied for imports to China. A process feed and concentrate blending strategy has been adopted as the primary method to manage

average arsenic grade in the 10 to 20k tonne shipments planned. Penalties for arsenic have been allowed for in the Scoping Study. As more variability flotation data comes to hand and the flowsheet is developed the control strategy and marketing economics will be reassessed. Alternative controls for management of arsenic have been identified for consideration including:

Gravity separation of nickeline which when testing an ARM master composite removed approximately 50% of feed arsenic from the flotation feed. The high arsenic concentrate could then be control blended back into the concentrate, sold as a separate product, or processed via an alternative method. Optimising reagent dosage in flotation including reduction of the  $\text{CuSO}_4$  activator. Sodium cyanide depression as practiced at the Cosmic Boy concentrator.

Downstream hydrometallurgical processing of the concentrate aimed at fixing arsenic within a stable form for tails disposal.

For this Scoping Study, a target average nickel concentrate grade of 10.1% was adopted. It is planned that a more rigorous economic assessment will be carried out once flowsheet development testwork has been completed and marketing feedback on payables and penalties has been better established. In addition, master composite samples from each deposit will undergo analysis for the full suite of PGEs as elements such as iridium and rhodium are likely to be elevated and so potentially add to the concentrate payability.

For future works, it is recommended that the baseline variability testwork program be completed as planned and then further flowsheet development testing is carried out on master composites from each deposit and average schedule feed blends. This more advanced testing should use site water or synthetic solutions representative of the expected process water. The results from this work will be used to reassess and optimise the existing mine plan and processing flowsheet to meet the concentrate specification objectives while minimising costs and penalties.

## Processing Costs

Capital and operating costs were estimated to a  $\pm 40\%$  accuracy for the 800ktpa process plant (Concentrator) based on the conceptual design basis. Estimated costs are presented in Australian dollars or United States dollars where specified and have a base date of October 2023.

### Process Plant Capital Costs

The capital cost estimate was developed for an 800ktpa process plant and associated infrastructure. The estimate is based on the process flowsheet shown in Figure 23 including the major plant equipment described in Table 25.

The estimate is based on factoring from Capital Costs for areas of similar process plants from recent studies or Projects undertaken by Wood. Factoring for time indexation and or capacity differences was applied as required. The currency conversion was assumed to be  $\text{US}\$0.65 = \text{A}\$1.00$ . Estimate costs have a base date of October 2023.

The estimate structure is based on the following categories:

- **Direct Costs:** permanent equipment, freight to site, construction labour and equipment, contractors' supervision and overheads, and other costs incurred during the construction of the processing plant.
- **Indirect Costs:** temporary construction facilities plus engineering, procurement and construction management services.
- **Growth Allowances:** allocation for the likely increase in cost during the development and refinement of specifications.

- **Owners Costs:** management and owner engineering.

The following estimate inclusions apply:

- Processing Plant and associated infrastructure including emergency power, plant buildings, raw water supply line from an estimated bore field.
- First fill reagents and consumables, spares, vendor representation and commissioning assistance allowance.
- EPCM allowance.
- Owners’ costs associated with direct and indirect costs.
- A 2Mdm tailing storage facility is included in the initial process plant cost estimate.

The following estimate exclusions apply:

- All costs associated with the mining area.
- Building of the ROM pad to feed the process.
- Power infrastructure and supply.
- Area infrastructure; water supply, roads, and stormwater prevention and diversion.
- Regional infrastructure; roads, and communication connection.
- All taxes, levies and charges.
- Camp construction.
- Owner’s sunk cost.
- Owner’s contingency.

**Table 27 - Process Plant Construction Capital Cost**

ITEM	Capital Cost (AUD\$M)
Direct Cost	78.2
Indirect Cost	16.6
Growth Allowance	9.4
<b>Subtotal</b>	<b>104.3</b>
Owners Cost	6.6
<b>TOTAL</b>	<b>110.9</b>

## Process Plant Operating Costs

The operating cost has been estimated to an accuracy of ±40% for an 800ktpa nickel concentrator and associated infrastructure delivering 97,369 tonnes (dry basis) of concentrate to China.

Estimated costs are presented in Australian dollars or United States dollars where specified and consider total or unit costs for an average processing year. The currency conversion was assumed to be US\$0.65 = AU\$1.00. Estimate costs have a base date of October 2023.

The estimate is built up based on reagent consumptions indicated by available testwork, the average electrical power demand and reference information, or factors derived from recent studies or projects undertaken by Wood.

The estimate is detailed to WBS Area level based on a preliminary work breakdown structure (WBS) and the high-level mechanical equipment list developed by Wood to suit the process flowsheet.

The following estimate exclusions apply:

- All mining costs.
- All environmental monitoring, and rehabilitation or closure costs.
- Any licence fees or royalties.
- Project insurances.
- Any impact of foreign exchange rate fluctuations.
- Income taxes, Goods and Services Tax, duties or similar imposts.
- Raw water costs (from an established bore field).

A summary of the operating costs estimated for the concentrator and concentrate transport in 10kt to 20kt shipments from Esperance Port to the Port of Qindao in China is presented in Table 28 and Table 29. An average annual operating cost of A\$37m, equivalent to US\$1.19/lb of nickel, is estimated for this Scoping Study.

**Table 28 - Process Plant Operating Cost Estimate**

Process Operating Costs by Cost Centre					
Cost Centre	Annual Cost	Throughput Basis	Throughput Basis	Production Basis	Production Basis
	(A\$ M/a)	(A\$/t Dry Feed)	(A\$/t dry concentrate)	(A\$/lb Ni)	(US\$/lb Ni)
Electrical Power	6.54	8.17	67.14	0.3	0.2
Labour	7.55	9.44	77.57	0.35	0.23
Consumables	3.31	4.14	34.03	0.15	0.1
Maintenance	1.98	2.48	20.39	0.09	0.06
Miscellaneous	2.31	2.88	23.68	0.11	0.07
Reagents	1.6	2	16.44	0.07	0.05
G&A (excludes admin. labour)	1.57	1.97	16.16	0.07	0.05
<b>Subtotal – Process Opex</b>	<b>24.87</b>	<b>31.09</b>	<b>255.4</b>	<b>1.15</b>	<b>0.75</b>

**Table 29 -Concentrate Transport Costs**

YEAR	Rate	Year 1	Year 2	Year 3	Year 4	Year 5	Year 6	Year 7	Year 8	TOTAL
Concentrate Produced (dmt)		0	56,660	87,442	97,263	94,055	104,756	101,112	75,380	<b>616,668</b>
Concentrate Shipped (dmt)		0	50,000	84,500	100,500	94,000	104,500	100,500	82,668	<b>616,668</b>
Moisture (%)		6%	6%	6%	6%	6%	6%	6%	6%	
Concentrate Shipped (wmt)		0	53,000	89,570	106,530	99,640	110,770	106,530	87,628	<b>653,668</b>
Con Transport Costs (wmt)										
Haulage to Esperance (AUD\$)	\$36.00	\$0	\$1,908,000	\$3,224,520	\$3,835,080	\$3,587,040	\$3,987,720	\$3,835,080	\$3,154,620	<b>\$23,532,060</b>
Storage Container Loading (AUD\$)	\$5.20	\$0	\$275,600	\$465,764	\$553,956	\$518,128	\$576,004	\$553,956	\$455,667	<b>\$3,399,075</b>
Receiving Agent (AUD\$)	\$7.69	\$0	\$81,538	\$137,800	\$163,892	\$153,292	\$170,415	\$163,892	\$134,813	<b>\$1,005,644</b>
Esperance Port Costs (AUD\$)	\$1.54	\$0	\$407,692	\$689,000	\$819,462	\$766,462	\$852,077	\$819,462	\$674,064	<b>\$5,028,218</b>
Assays (AUD\$)	\$1.85	\$0	\$97,846	\$165,360	\$196,671	\$183,951	\$204,498	\$196,671	\$161,775	<b>\$1,206,772</b>
Overseas Freight (AUD\$)	\$53.85	\$0	\$2,854,050	\$4,823,345	\$5,736,641	\$5,365,614	\$5,964,965	\$5,736,641	\$4,718,786	<b>\$35,200,040</b>
Insurance (AUD\$)	\$4.85	\$0	\$225,245	\$382,063	\$453,324	\$423,108	\$468,529	\$448,883	\$366,456	<b>\$2,767,608</b>
<b>TOTAL</b>	<b>\$110.97</b>	<b>\$0</b>	<b>\$5,849,972</b>	<b>\$9,887,852</b>	<b>\$11,759,025</b>	<b>\$10,997,594</b>	<b>\$12,224,209</b>	<b>\$11,754,584</b>	<b>\$9,666,182</b>	<b>\$72,139,417</b>

## Milling Schedule

The processing plant is scheduled for commissioning in month 16 after a 15-month construction period. Mill throughput is scheduled at only 40kt for the first month with only 480kt of ore scheduled for processing in the first year. After year 2 the mill production increases and peaks at the name plate capacity of 800kt/yr in years 4 to 7. During this period Ore ROM stocks average well above 100kt allowing for mill feed blending options.

Early ROM ore stocks are planned to peak at 123kt in month 17. Mine production peaks in year 4 with ROM stocks peaking at 203kt in month 85. After year 7 ROM stocks then continually deplete with final feed through the plant in month 94.

Mill concentrate production will be stockpiled on site for transport in bulk to a trucking yard in Esperance a haul distance of 290km. The concentrate is then planned to be transferred from a bulk storage shed to rotainers before being transported to the port for loading as a bulk product for overseas export.

The first concentrate shipment of 10kt is planned for month 17. Thereafter a concentrate shipment is planned every two months to provide consistent cashflow for the operation. The average shipment size planned for the life of the operation is 15.8kt with the final shipment in month 94.

Life of mine monthly mill tailings production averages 56,087 dmt with total estimated LOM tailings of 4.431M dmt. The second stage tailings dam is planned for construction completion in month 39 and has a planned capacity of 3M dmt. The total planned tailings dam capacity is 5M dmt.

## Site Infrastructure

### Site Power

The Mt Edwards Nickel Operation requires power for 4 underground mining operations, an 800ktpa nickel concentrator, administration, 250 man camp, and core yard.

Several power options included a combination of diesel, trucked LNG, and solar were considered. Given the location, scope, and length of the operation the initial focus has been on utilising the nearby available grid power.

The closet mains power supply is a 66kV substation switch yard located approximately 4.7km south west of Widgie 3 from which power is available to the site Capital allowance for surface transformers and power lines is allowed for within milling capex with mine based transformers and reticulation in each proposed mine development cost.

### Site Water Supply

The Mt Edwards Nickel Operation plan requires reliable water supply for the operation to run the nickel concentrator and provide potable water for offices, ablutions and the camp. The Project also has current water resources located in the 132N, Widgie 3 and 26N underground workings.

Each of the 4 underground mines will have a water supply recirculation system including two (2) surface storage dams and water tanks. These circuits are assumed to have a slightly negative water balance given all existing information. Unless there is significant additional water capture from storms, or unanticipated additional ground water ingress some water over time may need to be added to these circuits from the current reserves.

The mining leases and surrounding areas contain ground water resources with multiple aquifers located proximal from the planned process plant site. To date no hydrological work pertaining to the Project has been carried out to confirm quantity or quality of water available.

### Site Camp (Workforce Accommodation)

It has been assumed the workforce will be made up primarily of FIFO workers with a minor component residential in Kambalda or Kalgoorlie

Initial accommodation in months 1 to 4 will be provided for FIFO workers/contractors in the Coolgardie Shire owned Kambalda Village. It currently has a capacity of 200 rooms and is presently being upgraded to provide an additional 150.

From month 5 forward, it is scheduled that the 250-person onsite camp will be operational with current maximum onsite numbers for the operation estimated at 188 in month 50. The resulting spare 62 rooms have been included in the camp size to allow accommodation for ad hoc requirements.

The estimated capital cost of the 250-man camp is \$15M and the construction period 4 months. The estimated cost per man day for each worker housed in the onsite camp from month 5 forward is \$60/day in addition to a fixed \$50k/mth cost management fee for the caterer to manage the onsite village.



An additional cost per man day for each worker housed in Kambalda during the first 4 months of \$100/day has been included in the Project costs. So, the resulting applied accommodation costs for this period is \$160/man day plus the \$50k per month fixed charge.

## Workforce Transport

FIFO Employees and Contractors will be offered air transport on chartered flights from Perth Airport to the Kambalda West Airport. The Kambalda West Airport main runway is 1,800m long and has an all weather surface that is usable for medium sized commercial aircraft. The estimated cost per person per flight from Perth to Kambalda West used in this study is \$420 one way.

There are 6 onsite buses costed in the study for the transportation of workers from the Kambalda airport to the operation camp as well as twice daily to each mine site. Senior mine site personnel will also have access to a number of light vehicles providing additional transport options outside of bus times.

## Site Roads

The Mt Edwards Project is accessible via a combination of gazetted roads from Kambalda and Coolgardie. There are also numerous private roads that can be used to access the Project from the Coolgardie-Esperance Highway.

\$3.8M has been allocated for the building of new roads which includes a 13km ore haulage road as well as an additional main road turn out.

## Telecommunications

Telephone and internet communication will be required onsite. They will be provided by internet linked services. Both VHF and UHF radio communications will be established at each mine site and a comms hut established. The main administration office will house a communications server room with fibre optic cable being reticulated to each site via the extensive overhead powerline system.

Overall \$747k has been allocated for the establishment of onsite communications.

## Site Layouts

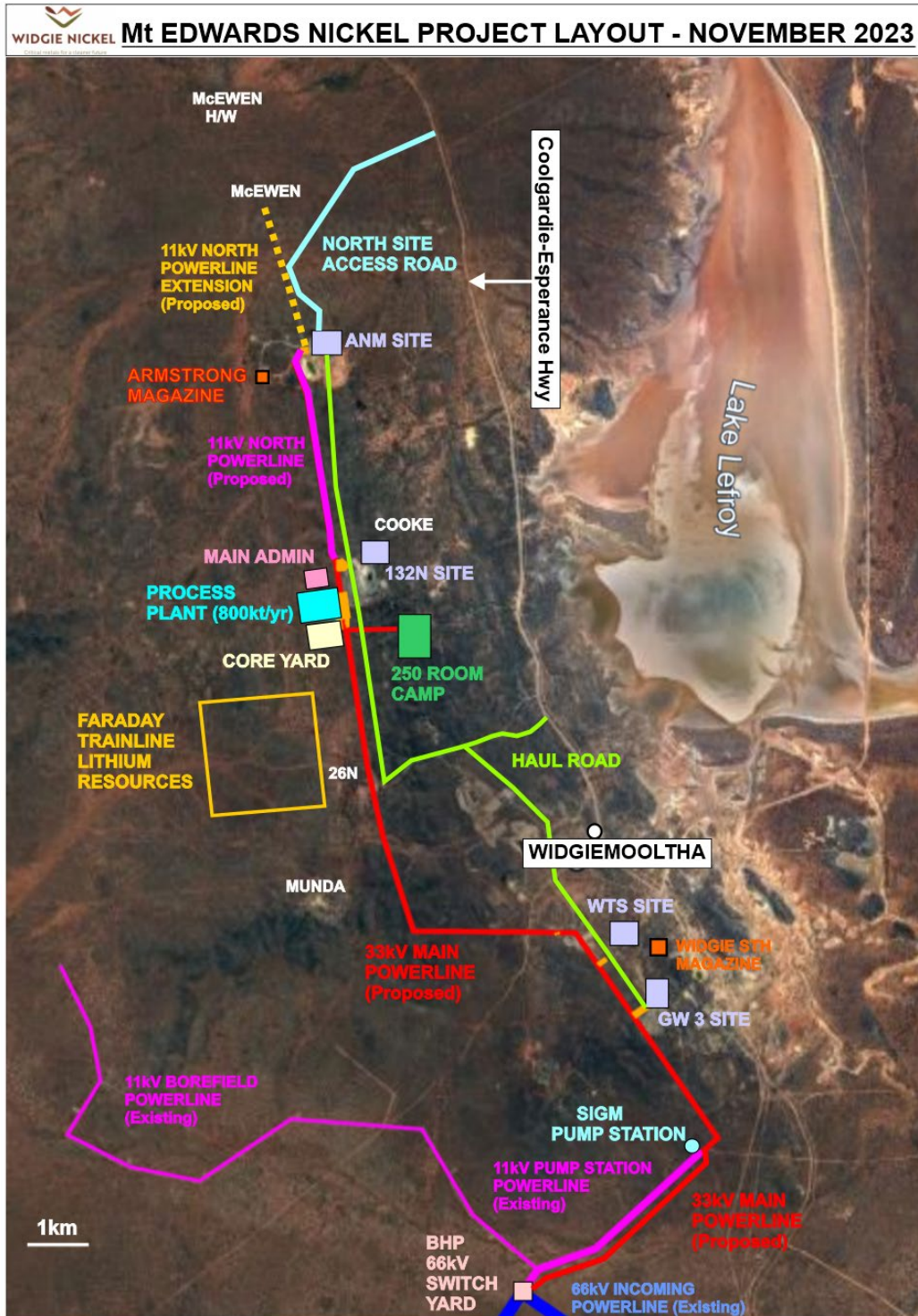

Figure 24 - Mt Edwards Nickel Project Conceptual Layout



**Figure 25 - Central Facilities Conceptual Layout**

The Mt Edwards Nickel Project will require several important central facilities for efficient operations. These common facilities are planned for construction close to the centroid of the deposits and other prospective resources. This main centre, adjacent to the 132N mine is planned to comprise a main administration complex with medical facilities, the nickel concentrator, 250-man accommodation village, main store, maintenance offices with workshop and core yard facility.

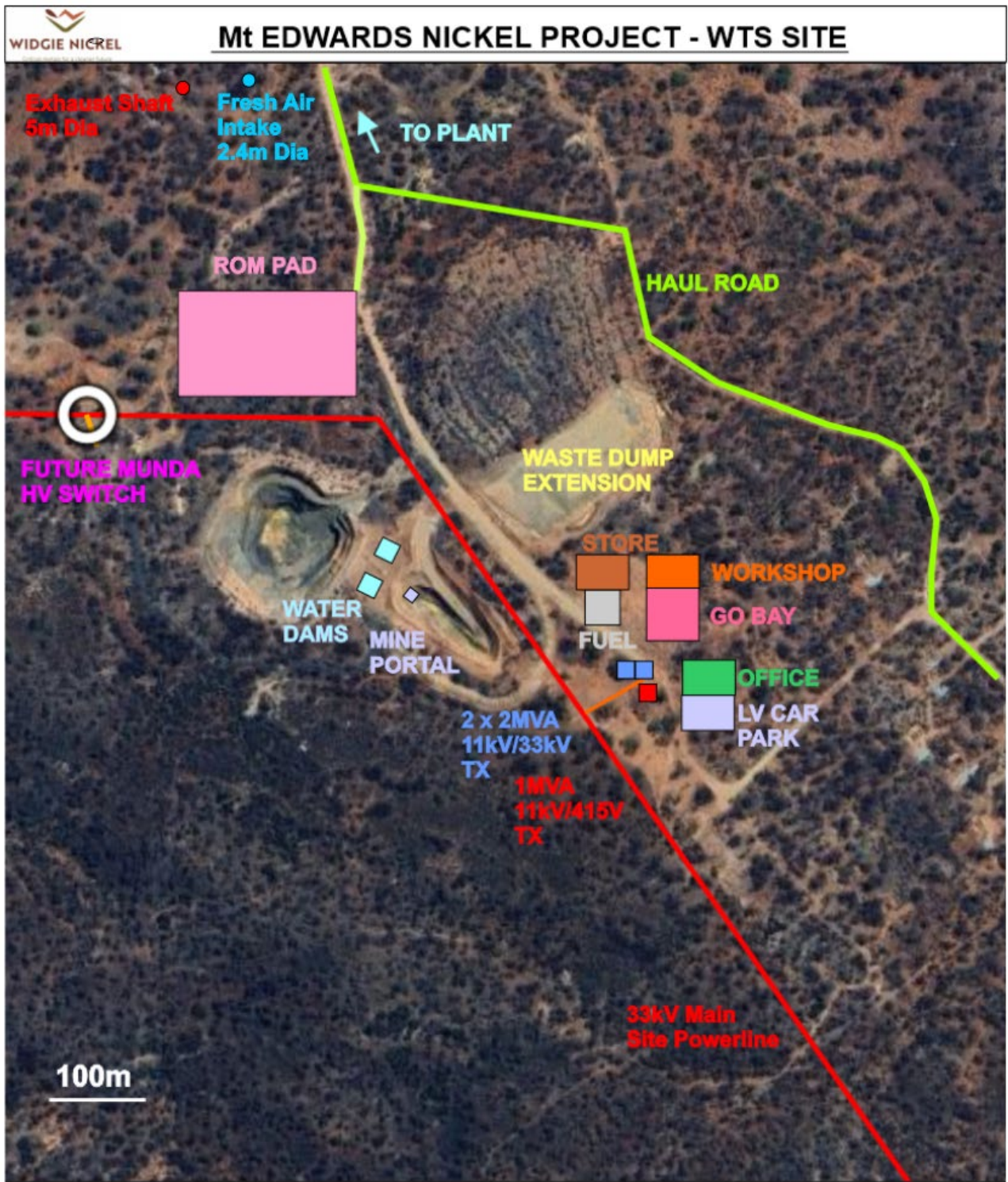
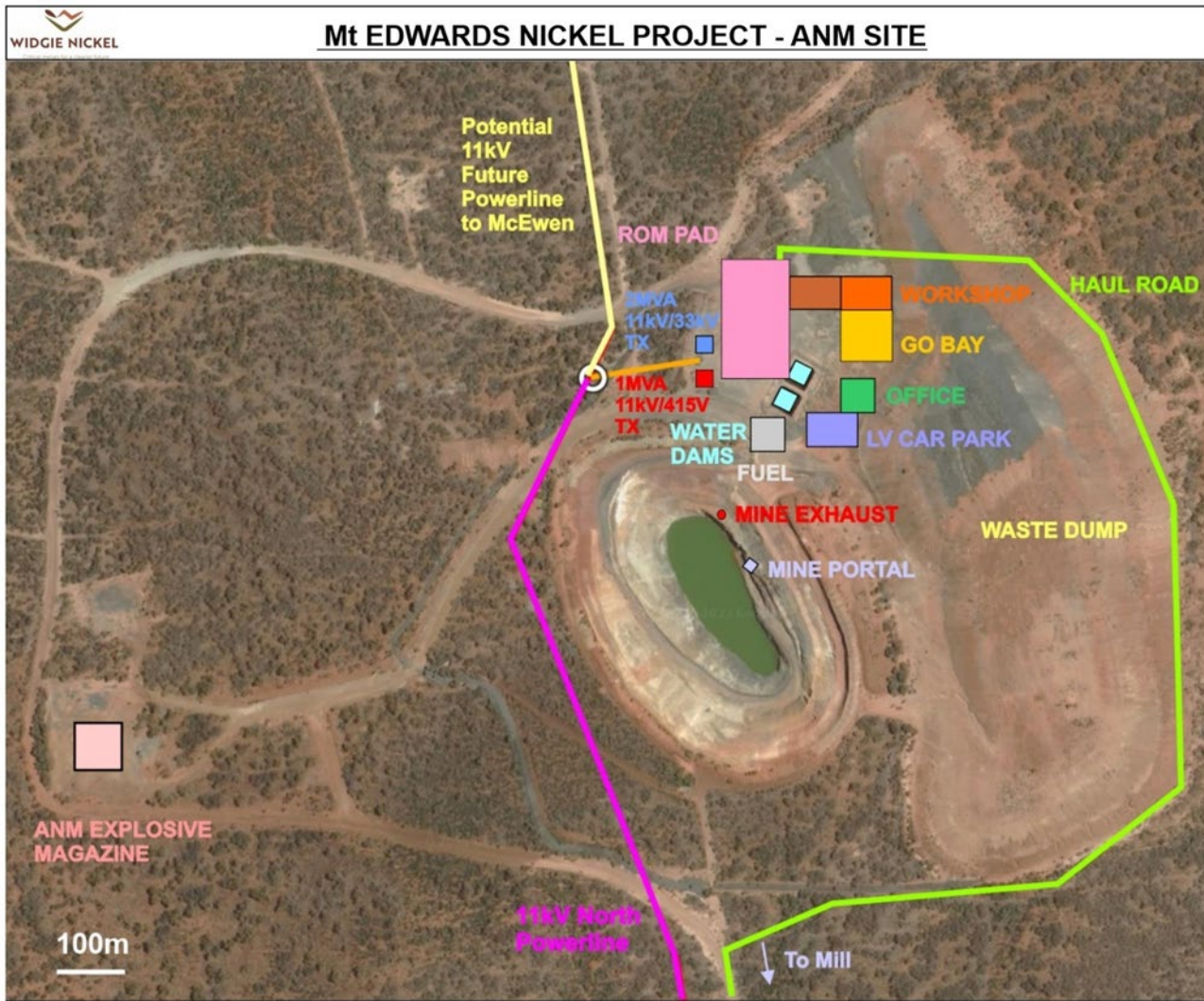

Figure 26 – Widgie Townsite Surface Layout



Figure 27 – Widgie 3 Surface Layout



**Figure 28 -Armstrong Surface Layout**



Figure 29 – 132N Surface Layout

## Environmental and Social

The Project is located within the Eastern Goldfields Province in the Archaean Yilgarn Craton of Western Australia. The regional topography is gently undulating with occasional ranges of low hills. Soils are principally brown calcareous earths and are poorly developed over greenstone belts. Saline and subsaline soils are common adjacent to drainage channels and salt lakes.

Playa lakes such as Lake Lefroy are prominent within the Salina Land Division and occur as dendritic and partly interconnected chains that outline fossil drainage systems.

The vegetation in the region is dominated by Eucalypt woodlands which become more open and develop a saltbush/bluebush understorey on the more calcareous soils. The Project is located in an area in which previous land disturbance exists. The Project will utilise existing infrastructure and aims to limit land use to previously disturbed areas where possible thereby minimising new disturbance.

Widgie Nickel staff and representative consultants have and will continue to communicate and liaise with various stakeholders including Traditional Owners (Marlinyu Ghoorlie & Ngadju) and those who are recognised as custodians for the land, regulatory bodies, the Widgiemooltha/Kambalda community, pastoral lease holders and the Shire of Coolgardie.

These engagements have involved the likely mining plan and proposed infrastructure layouts and likely timing of events for the construction and operational aspects of the Project.

All the study work required to support the approvals, and ongoing management of the Project include:

- Level 2 flora and vegetation studies.
- Level 2 fauna assessments.
- Hydrology and hydrogeology studies to determine the impacts of water abstraction and drawdown, discharge to the environment (open pits and storage ponds) and changes to hydrological regimes associated with mining infrastructure.
- Soil characterisation studies.
- Waste characterisation Studies, including acid generation potential.
- Tailings characterisation studies.

The information gathered by the various studies will be used to update the site environmental management plans and procedures, to ensure the construction and operation and closure of the Project can be done with the highest levels of environmental management and protection. Widgie has reasonable grounds to expect that all necessary approvals and contracts will eventuate as required by the Project development schedule. No approvals have been sought at this time.



## Concentrate Movement and Offtake Terms

Concentrate production will be stockpiled on site for transport in bulk to a trucking yard in Esperance a haul distance of 290km. The concentrate is then planned to be transferred from a bulk storage shed to sealed shipping rotainers before being transported to the port for loading as a bulk product for overseas export.

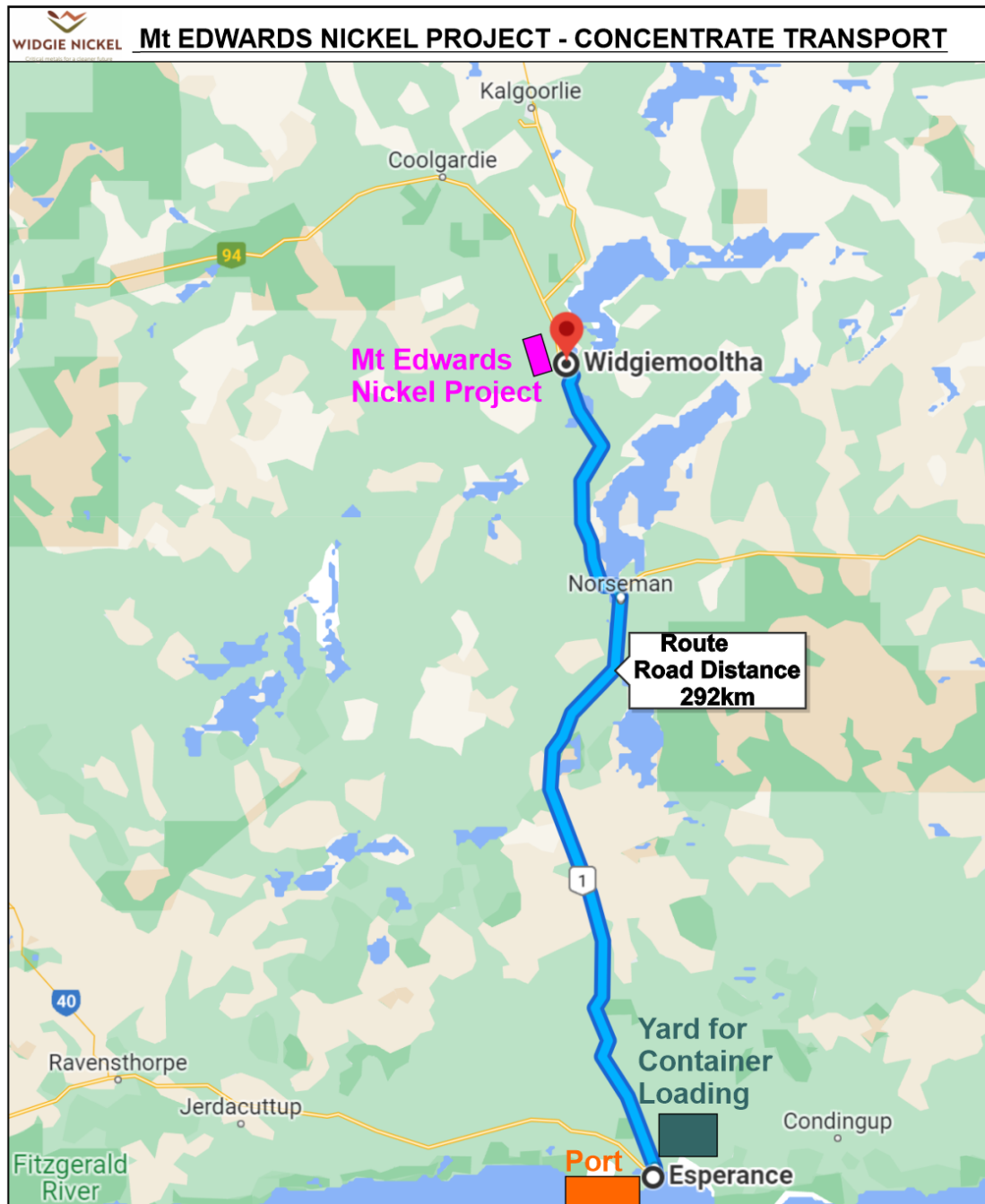

**Figure 30 - Concentrate Transport Route**

## Concentrate Offtake Terms

Third party concentrate traders were consulted with to provide indicative terms for nickel concentrate sales. This was adopted cognisant of publicly available information sourced from other producers operating in the region. A standard penalty suite as per Table 31 was adopted.

**Table 30 - Concentrate Offtake Terms**

ITEM	Unit	Value	Minimum Payable Grades	Average Con Grade
<b>Expected Offtake Terms</b>				
Payability Ni	%	80	7.50%	10.1%
Payability Cu	%	45	30,000ppm	13,226ppm
Payability Co	%	40	3,000ppm	2,524ppm
Payability Au	%	50	1g/t	0.59g/t
Payability Pd	%	50	1g/t	1.64g/t
Payability Pt	%	50	1g/t	0.45g/t
Treatment Costs (TC)	US\$/dmt	0		

\*C, Au, and Pt 0% payability applied in the Scoping Study

**Table 31 - Indicative Concentrate Offtake Penalty Terms**

ITEM	Unit	Applicable Grade	Penalty	Average Con Grade
<b>Offtake Penalties</b>				
Nickel (Ni)	%	Penalty applicable for Ni<9%	Less 1% Payable per 1%<9% Ni	10.10%
Magnesium Oxide (MgO)	%	Penalty applicable for MgO>5%	US\$6/dmt for each 1% over 5%	13.08%
Arsenic (As)	ppm	Max Allowed 5,000ppm	US\$2/dmt for each 100pm above 1,000ppm	2,709ppm

## Concentrate Offtake Revenue

The estimated offtake Net Revenue (minus transportation costs and offtake penalties) is provided in the below Table 32. These amounts are given in Australian dollars and are exclusive of payable royalties and taxation.

**Table 32 - Estimated Concentrate Net Revenue**

YEAR	Year 1	Year 2	Year 3	Year 4	Year 5	Year 6	Year 7	Year 8	TOTAL
Concentrate Shipped (dmt)	0	50,000	84,500	100,500	94,000	104,500	100,500	82,668	<b>616,668</b>
<b>Gross Revenue (AUS\$)</b>									
Nickel	\$0	\$149,169,231	\$252,096,000	\$299,830,154	\$280,438,154	\$311,763,692	\$299,830,154	\$246,631,152	<b>\$1,839,758,537</b>
Copper	\$0	\$0	\$0	\$0	\$0	\$0	\$0	\$0	<b>\$0</b>
Cobalt	\$0	\$0	\$938,848	\$0	\$0	\$0	\$0	\$0	<b>\$938,848</b>
Gold	\$0	\$0	\$0	\$0	\$0	\$0	\$0	\$0	<b>\$0</b>
Palladium	\$0	\$3,271,725	\$6,516,882	\$6,388,504	\$4,796,574	\$5,872,171	\$6,080,442	\$4,566,019	<b>\$37,492,316</b>
Platinum	\$0	\$0	\$0	\$0	\$0	\$0	\$0	\$0	<b>\$0</b>
<b>Total Gross Revenue</b>	<b>\$0</b>	<b>\$152,440,955</b>	<b>\$259,551,731</b>	<b>\$306,218,658</b>	<b>\$285,234,727</b>	<b>\$317,635,863</b>	<b>\$305,910,596</b>	<b>\$251,197,171</b>	<b>\$1,878,189,701</b>
<b>Revenue Deductions (Past Gate)</b>									
Concentrate Transport	\$0	\$5,849,972	\$9,887,852	\$11,759,025	\$10,997,594	\$12,224,209	\$11,754,584	\$9,666,182	<b>\$72,139,417</b>
Offtake Penalties	\$0	\$8,102,727	\$7,878,603	\$10,823,006	\$13,037,271	\$10,885,198	\$8,849,746	\$5,414,573	<b>\$64,991,124</b>
<b>Revenue Before Royalties (AUS\$)</b>	<b>\$0</b>	<b>\$138,488,257</b>	<b>\$241,785,275</b>	<b>\$283,636,626</b>	<b>\$261,199,862</b>	<b>\$294,526,457</b>	<b>\$285,306,267</b>	<b>\$236,116,417</b>	<b>\$1,741,059,161</b>

## Financial Model

A full financial model has been developed for the Project using where possible first principal costs. This model provides transparency and allows flexibility with future Project cost options such as whether to adopt an owner mining model, use a main mining contractor or use a hybrid structure for the mining operation. All costs have been supported by budget quotations in the case of major cost items or from existing databases as each case applies.

This model has also assumed revenue is sourced via an overseas offtake arrangement with the concentrate being carted from site via road and then shipped out of the Esperance port to a mainland China port.

**Table 33 - General and Costs Associated Project Assumptions**

PROJECT YEAR	UNIT	Year 1	Year 2	Year 3	Year 4	Year 5	Year 6	Year 7	Year 8
Foreign Exchange Rate (\$US to \$AUS)	%	0.65	0.65	0.65	0.65	0.65	0.65	0.65	0.65
Diesel Cost (\$US/litre)	US\$/Litre	\$1.20	\$1.20	\$1.20	\$1.20	\$1.20	\$1.20	\$1.20	\$1.20
Diesel Cost (\$Aus/litre)	AUD\$/Litre	\$1.85	\$1.85	\$1.85	\$1.85	\$1.85	\$1.85	\$1.85	\$1.85
Diesel Rebate (\$Aus/litre)	AUD\$/Litre	\$0.48	\$0.48	\$0.48	\$0.48	\$0.48	\$0.48	\$0.48	\$0.48
Widgie Camp Cost	\$/man day	\$60	\$60	\$60	\$60	\$60	\$60	\$60	\$60
Kambalda Camp Premium	\$/man day	\$100	\$100	\$100	\$100	\$100	\$100	\$100	\$100
Kambalda Charter Flight Cost	\$/person	\$420	\$420	\$420	\$420	\$420	\$420	\$420	\$420
Power Cost (\$/kWhr) - Grid	\$/kWhr	\$0.20	\$0.20	\$0.20	\$0.20	\$0.20	\$0.20	\$0.20	\$0.20
Power Cost (\$/kWhr) - Diesel Premium	\$/kWhr	\$0.35	\$0.35	\$0.35	\$0.35	\$0.35	\$0.35	\$0.35	\$0.35
Concentrate Average Grade (Ni%)	%	10.1	10.1	10.1	10.1	10.1	10.1	10.1	10.1
Concentrate Average Moisture	%	6.00	6.00	6.00	6.00	6.00	6.00	6.00	6.00
Con Haulage Freight (Esperance)	AUS\$wmt	\$36.00	\$36.00	\$36.00	\$36.00	\$36.00	\$36.00	\$36.00	\$36.00
Con Overseas Freight (China)	AUS\$wmt	\$53.85	\$53.85	\$53.85	\$53.85	\$53.85	\$53.85	\$53.85	\$53.85
<b>Milling Recovery</b>									
Nickel (%)	%	79%	79%	79%	79%	79%	79%	79%	79%
Copper (%)	%	93%	93%	93%	93%	93%	93%	93%	93%
Cobalt (%)	%	76%	76%	76%	76%	76%	76%	76%	76%
Arsenic (%)	%	84%	84%	84%	84%	84%	84%	84%	84%
Gold (%)	%	74%	74%	74%	74%	74%	74%	74%	74%
Palladium (%)	%	76%	76%	76%	76%	76%	76%	76%	76%
Platinum (%)	%	44%	44%	44%	44%	44%	44%	44%	44%
Fe (%)	%	26%	26%	26%	26%	26%	26%	26%	26%
MgO (%)	%	7%	7%	7%	7%	7%	7%	7%	7%
Sulphur (%)	%	58%	58%	58%	58%	58%	58%	58%	58%
<b>ROYALTIES</b>									
WA Govt - Nickel	%	2.50%	2.50%	2.50%	2.50%	2.50%	2.50%	2.50%	2.50%
WA Govt - Copper	%	2.50%	2.50%	2.50%	2.50%	2.50%	2.50%	2.50%	2.50%
WA Govt - Cobalt	%	2.50%	2.50%	2.50%	2.50%	2.50%	2.50%	2.50%	2.50%
WA Govt - Platinoids	%	2.50%	2.50%	2.50%	2.50%	2.50%	2.50%	2.50%	2.50%
Other Weighted Average	%	2.83%	2.83%	2.83%	2.83%	2.83%	2.83%	2.83%	2.83%
Other Royalty 1 - WTS, Gillett, W3	%	2.50%	2.50%	2.50%	2.50%	2.50%	2.50%	2.50%	2.50%
Other Royalty 2 - 132N, ANM	%	4.00%	4.00%	4.00%	4.00%	4.00%	4.00%	4.00%	4.00%

The commodity price and offtake assumptions are the same for each year of the financial model.

**Table 34 - Commodity Price and Offtake Assumptions**

PROJECT YEAR	UNIT	Year 1	Year 2	Year 3	Year 4	Year 5	Year 6	Year 7	Year 8
<b>Nickel Pricing</b>									
\$US Nickel price per tonne	US\$/t	\$24,000	\$24,000	\$24,000	\$24,000	\$24,000	\$24,000	\$24,000	\$24,000
\$AUS Nickel price per tonne	AUD\$/t	\$36,923	\$36,923	\$36,923	\$36,923	\$36,923	\$36,923	\$36,923	\$36,923
\$US Nickel Price per pound	US\$/lb	\$10.89	\$10.89	\$10.89	\$10.89	\$10.89	\$10.89	\$10.89	\$10.89
\$AUD Nickel Price per pound	AUD\$/lb	\$16.75	\$16.75	\$16.75	\$16.75	\$16.75	\$16.75	\$16.75	\$16.75
<b>Copper Pricing</b>									
\$US Copper price per tonne	US\$/t	\$9,000	\$9,000	\$9,000	\$9,000	\$9,000	\$9,000	\$9,000	\$9,000
\$AUS Copper price per tonne	AUD\$/t	\$13,846	\$13,846	\$13,846	\$13,846	\$13,846	\$13,846	\$13,846	\$13,846
\$US Copper Price per pound	US\$/lb	\$4.08	\$4.08	\$4.08	\$4.08	\$4.08	\$4.08	\$4.08	\$4.08
\$AUD Copper Price per pound	AUD\$/lb	\$6.28	\$6.28	\$6.28	\$6.28	\$6.28	\$6.28	\$6.28	\$6.28
<b>Cobalt Pricing</b>									
\$US Cobalt price per tonne	US\$/t	\$45,000	\$45,000	\$45,000	\$45,000	\$45,000	\$45,000	\$45,000	\$45,000
\$AUS Cobalt price per tonne	AUD\$/t	\$69,231	\$69,231	\$69,231	\$69,231	\$69,231	\$69,231	\$69,231	\$69,231
\$US Cobalt Price per pound	US\$/lb	\$20.41	\$20.41	\$20.41	\$20.41	\$20.41	\$20.41	\$20.41	\$20.41
\$AUD Cobalt Price per pound	AUD\$/lb	\$31.40	\$31.40	\$31.40	\$31.40	\$31.40	\$31.40	\$31.40	\$31.40
<b>Gold Pricing</b>									
\$US Gold price per ounce	US\$/oz	\$2,000	\$2,000	\$2,000	\$2,000	\$2,000	\$2,000	\$2,000	\$2,000
\$AUS Gold price per ounce	AUD\$/oz	\$3,077	\$3,077	\$3,077	\$3,077	\$3,077	\$3,077	\$3,077	\$3,077
<b>Palladium Pricing</b>									
\$US Palladium price per ounce	US\$/oz	\$1,500	\$1,500	\$1,500	\$1,500	\$1,500	\$1,500	\$1,500	\$1,500
\$AUS Palladium price per ounce	AUD\$/oz	\$2,308	\$2,308	\$2,308	\$2,308	\$2,308	\$2,308	\$2,308	\$2,308
<b>Platinum Pricing</b>									
\$US Platinum price per ounce	US\$/oz	\$1,000	\$1,000	\$1,000	\$1,000	\$1,000	\$1,000	\$1,000	\$1,000
\$AUS Platinum price per ounce	AUD\$/oz	\$1,538	\$1,538	\$1,538	\$1,538	\$1,538	\$1,538	\$1,538	\$1,538
<b>OFFTAKE TERMS</b>									
<b>Payability</b>									
Nickel	%	80%	80%	80%	80%	80%	80%	80%	80%
Copper	%	45%	45%	45%	45%	45%	45%	45%	45%
Cobalt	%	40%	40%	40%	40%	40%	40%	40%	40%
Gold	%	50%	50%	50%	50%	50%	50%	50%	50%
Palladium	%	50%	50%	50%	50%	50%	50%	50%	50%
Platinum	%	50%	50%	50%	50%	50%	50%	50%	50%

## Project Costs

The Project costs where possible have been sourced by recent (within 6 months) pricing quotes from legitimate suppliers operating in the Kambalda region. The Project costs have been broken down into Operating and Capital costs. Where possible, costs have been further broken down into Fixed and Variable categories.

The financial model costs have also been grouped into the below cost centres:

- Mining Direct Costs
- Mine Tech Services Costs
- Milling Costs (Includes Ore Cartage)
- Surface Infrastructure Costs (Includes project Construction)
- Administration Costs (Includes Flights and Accommodation)
- Off Site Concentrate Movement Costs (Includes Offtake Costs)
- Payable Royalties
- Mine Closure Costs

## Direct Mining Costs

These are the costs associated with all physical mining activities including the drilling, blasting, and movement of mined material. These costs also include the required services and infrastructure required for the mine. All major site related capital items have been included in these costs.

**Table 35 - Fixed Direct Mining Costs**

YEAR	Year 1	Year 2	Year 3	Year 4	Year 5	Year 6	Year 7	Year 8	TOTAL
<b>FIXED MINING COSTS</b>									
<b>Mining - Machinery Ownership</b>									
WTS	\$2,238,800	\$2,880,800	\$3,260,800	\$3,651,800	\$3,928,800	\$2,978,800	\$2,249,000	\$0	<b>\$21,188,800</b>
GW3	\$3,006,500	\$5,287,000	\$5,653,000	\$4,378,000	\$3,636,000	\$2,678,000	\$2,478,000	\$2,065,000	<b>\$29,181,500</b>
ANM	\$0	\$0	\$0	\$0	\$2,205,200	\$2,508,200	\$2,665,200	\$405,300	<b>\$7,783,900</b>
132N	\$0	\$0	\$0	\$0	\$334,200	\$2,245,200	\$2,901,200	\$1,949,000	<b>\$7,429,600</b>
<b>SUBTOTAL</b>	<b>\$5,245,300</b>	<b>\$8,167,800</b>	<b>\$8,913,800</b>	<b>\$8,029,800</b>	<b>\$10,104,200</b>	<b>\$10,410,200</b>	<b>\$10,293,400</b>	<b>\$4,419,300</b>	<b>\$65,583,800</b>
<b>Mining - Manpower Wages</b>									
WTS	\$8,615,750	\$10,561,417	\$11,224,417	\$13,143,000	\$11,053,250	\$7,393,750	\$5,075,417	\$0	<b>\$67,067,000</b>
GW3	\$8,368,750	\$13,903,500	\$14,693,250	\$11,505,000	\$9,381,667	\$7,101,250	\$7,191,167	\$6,976,667	<b>\$79,121,250</b>
ANM	\$0	\$0	\$0	\$0	\$8,290,750	\$10,166,000	\$6,634,333	\$1,462,500	<b>\$26,553,583</b>
132N	\$0	\$0	\$0	\$0	\$1,012,917	\$8,777,167	\$9,987,250	\$6,593,167	<b>\$26,370,500</b>
<b>SUBTOTAL</b>	<b>\$16,984,500</b>	<b>\$24,464,917</b>	<b>\$25,917,667</b>	<b>\$24,648,000</b>	<b>\$29,738,583</b>	<b>\$33,438,167</b>	<b>\$28,888,167</b>	<b>\$15,032,333</b>	<b>\$199,112,333</b>
<b>Maintenance - Manpower Wages</b>									
WTS	\$3,766,750	\$4,478,500	\$4,972,500	\$6,058,000	\$4,693,000	\$3,289,000	\$2,399,583	\$0	<b>\$29,657,333</b>
GW3	\$0	\$0	\$0	\$0	\$0	\$0	\$164,667	\$823,333	<b>\$988,000</b>
ANM	\$0	\$0	\$1,976,000	\$2,726,750	\$1,644,500	\$347,750	\$0	\$0	<b>\$6,695,000</b>
132N	\$0	\$0	\$0	\$0	\$1,976,000	\$2,726,750	\$1,898,000	\$0	<b>\$6,600,750</b>
<b>SUBTOTAL</b>	<b>\$3,766,750</b>	<b>\$4,478,500</b>	<b>\$6,948,500</b>	<b>\$8,784,750</b>	<b>\$8,313,500</b>	<b>\$6,363,500</b>	<b>\$4,462,250</b>	<b>\$823,333</b>	<b>\$43,941,083</b>
<b>TOTAL MINING FIXED COSTS</b>	<b>\$25,996,550</b>	<b>\$37,111,217</b>	<b>\$41,779,967</b>	<b>\$41,462,550</b>	<b>\$48,156,283</b>	<b>\$50,211,867</b>	<b>\$43,643,817</b>	<b>\$20,274,967</b>	<b>\$308,637,217</b>
WTS	\$14,621,300	\$17,920,717	\$19,457,717	\$22,852,800	\$19,675,050	\$13,661,550	\$9,724,000	\$0	<b>\$117,913,133</b>
GW3	\$11,375,250	\$19,190,500	\$20,346,250	\$15,883,000	\$13,017,667	\$9,779,250	\$9,833,833	\$9,865,000	<b>\$109,290,750</b>
ANM	\$0	\$0	\$1,976,000	\$2,726,750	\$12,140,450	\$13,021,950	\$9,299,533	\$1,867,800	<b>\$41,032,483</b>
132N	\$0	\$0	\$0	\$0	\$3,323,117	\$13,749,117	\$14,786,450	\$8,542,167	<b>\$40,400,850</b>

**Table 36 - Variable Direct Mining Costs**

YEAR	Year 1	Year 2	Year 3	Year 4	Year 5	Year 6	Year 7	Year 8	TOTAL
<b>VARIABLE MINING COSTS</b>									
<b>Mining Machinery - Material Parts</b>									
WTS	\$1,445,200	\$1,671,600	\$1,939,600	\$1,965,800	\$2,044,800	\$1,552,800	\$1,189,000	\$0	<b>\$11,808,800</b>
GW3	\$1,669,000	\$2,880,800	\$3,075,200	\$2,397,600	\$1,984,400	\$1,630,400	\$1,430,400	\$1,192,000	<b>\$16,259,800</b>
ANM	\$0	\$0	\$0	\$0	\$1,661,200	\$1,692,241	\$1,850,308	\$223,800	<b>\$5,427,549</b>
132N	\$0	\$0	\$0	\$0	\$209,200	\$1,255,200	\$1,794,738	\$1,452,373	<b>\$4,711,511</b>
<b>SUBTOTAL</b>	<b>\$3,114,200</b>	<b>\$4,552,400</b>	<b>\$5,014,800</b>	<b>\$4,363,400</b>	<b>\$5,899,600</b>	<b>\$6,130,641</b>	<b>\$6,264,446</b>	<b>\$2,868,173</b>	<b>\$38,207,660</b>
<b>Mining Stores Costs</b>									
WTS	\$4,075,590	\$12,328,478	\$13,810,394	\$13,565,083	\$9,788,020	\$6,842,972	\$2,406,269	\$0	<b>\$62,816,805</b>
GW3	\$7,649,824	\$15,419,086	\$18,917,650	\$12,808,406	\$13,357,977	\$8,827,893	\$4,932,292	\$3,530,426	<b>\$85,443,554</b>
ANM	\$0	\$0	\$0	\$0	\$3,813,490	\$7,675,362	\$5,687,220	\$699,498	<b>\$17,875,570</b>
132N	\$0	\$0	\$0	\$0	\$471,784	\$3,755,197	\$6,787,619	\$4,846,769	<b>\$15,861,369</b>
<b>SUBTOTAL</b>	<b>\$11,725,414</b>	<b>\$27,747,564</b>	<b>\$32,728,043</b>	<b>\$26,373,489</b>	<b>\$27,431,271</b>	<b>\$27,101,424</b>	<b>\$19,813,399</b>	<b>\$9,076,693</b>	<b>\$181,997,298</b>
<b>Contractors</b>									
WTS	\$374,730	\$4,904,935	\$4,580,508	\$5,159,616	\$5,369,504	\$3,274,557	\$2,615,586	\$0	<b>\$26,279,436</b>
GW3	\$491,101	\$4,192,036	\$7,472,787	\$8,856,981	\$5,713,671	\$3,421,455	\$2,029,463	\$1,876,876	<b>\$34,054,369</b>
ANM	\$0	\$0	\$0	\$0	\$623,580	\$1,990,864	\$2,429,258	\$664,965	<b>\$5,708,667</b>
132N	\$0	\$0	\$0	\$0	\$0	\$300,000	\$1,917,345	\$2,657,919	<b>\$4,875,264</b>
<b>SUBTOTAL</b>	<b>\$865,831</b>	<b>\$9,096,971</b>	<b>\$12,053,295</b>	<b>\$14,016,596</b>	<b>\$11,706,755</b>	<b>\$8,986,876</b>	<b>\$8,991,652</b>	<b>\$5,199,759</b>	<b>\$70,917,735</b>
<b>Power</b>									
WTS	\$2,116,132	\$2,597,263	\$2,784,933	\$3,112,331	\$2,974,648	\$2,454,903	\$1,710,218	\$0	<b>\$17,750,429</b>
GW3	\$2,249,641	\$5,580,001	\$6,379,458	\$4,974,585	\$3,529,090	\$3,317,290	\$2,947,231	\$2,284,700	<b>\$31,261,997</b>
ANM	\$0	\$0	\$0	\$0	\$1,544,400	\$2,174,422	\$2,251,741	\$498,771	<b>\$6,469,334</b>
132N	\$0	\$0	\$0	\$0	\$110,058	\$1,800,399	\$2,342,360	\$1,561,427	<b>\$5,814,245</b>
<b>SUBTOTAL</b>	<b>\$4,365,773</b>	<b>\$8,177,264</b>	<b>\$9,164,391</b>	<b>\$8,086,916</b>	<b>\$8,158,197</b>	<b>\$9,747,015</b>	<b>\$9,251,550</b>	<b>\$4,344,898</b>	<b>\$61,296,004</b>
<b>Pumping</b>									
WTS	\$248,832	\$248,832	\$248,832	\$248,832	\$248,832	\$248,832	\$207,360	\$0	<b>\$1,700,352</b>
GW3	\$248,832	\$248,832	\$248,832	\$248,832	\$248,832	\$248,832	\$248,832	\$207,360	<b>\$1,949,184</b>
ANM	\$0	\$0	\$0	\$0	\$248,832	\$248,832	\$248,832	\$62,208	<b>\$808,704</b>
132N	\$0	\$0	\$0	\$0	\$41,472	\$248,832	\$248,832	\$207,360	<b>\$746,496</b>
<b>SUBTOTAL</b>	<b>\$497,664</b>	<b>\$497,664</b>	<b>\$497,664</b>	<b>\$497,664</b>	<b>\$787,968</b>	<b>\$995,328</b>	<b>\$953,856</b>	<b>\$476,928</b>	<b>\$5,204,736</b>
<b>VSD Fan Licensing (\$2.25k/mth per fan)</b>									



# Standalone Mt Edwards Project Scoping Study Highlights Nickel Potential

7 March 2024

WTS	\$36,000	\$119,250	\$146,250	\$202,500	\$216,000	\$137,250	\$31,500	\$0	<b>\$888,750</b>
GW3	\$103,500	\$522,000	\$722,250	\$490,500	\$378,000	\$378,000	\$281,250	\$168,750	<b>\$3,044,250</b>
ANM	\$0	\$0	\$0	\$0	\$76,500	\$162,000	\$153,000	\$13,500	<b>\$405,000</b>
132N	\$0	\$0	\$0	\$0	\$0	\$94,500	\$146,250	\$42,750	<b>\$283,500</b>
<b>SUBTOTAL</b>	<b>\$139,500</b>	<b>\$641,250</b>	<b>\$868,500</b>	<b>\$693,000</b>	<b>\$670,500</b>	<b>\$771,750</b>	<b>\$612,000</b>	<b>\$225,000</b>	<b>\$4,621,500</b>
<b>TOTAL VARIABLE MINING COSTS</b>	<b>\$20,708,382</b>	<b>\$50,713,113</b>	<b>\$60,326,692</b>	<b>\$54,031,066</b>	<b>\$54,654,291</b>	<b>\$53,733,034</b>	<b>\$45,886,903</b>	<b>\$22,191,452</b>	<b>\$362,244,934</b>
<b>Site Totals</b>									
WTS	\$8,296,484	\$21,870,359	\$23,510,516	\$24,254,162	\$20,641,804	\$14,511,314	\$8,159,933	\$0	<b>\$121,244,572</b>
GW3	\$12,411,899	\$28,842,755	\$36,816,176	\$29,776,904	\$25,211,971	\$17,823,870	\$11,869,467	\$9,260,111	<b>\$172,013,153</b>
ANM	\$0	\$0	\$0	\$0	\$7,968,002	\$13,943,722	\$12,620,358	\$2,162,742	<b>\$36,694,824</b>
132N	\$0	\$0	\$0	\$0	\$832,515	\$7,454,128	\$13,237,144	\$10,768,598	<b>\$32,292,385</b>

**Table 37 – All Mining Capital Costs**

YEAR	Year 1	Year 2	Year 3	Year 4	Year 5	Year 6	Year 7	Year 8	TOTAL
<b>MINING CAPITAL COSTS</b>									
<b>Widgie Town Site (WTS)</b>									
Lateral Mine Development	\$15,586,337	\$8,101,834	\$6,338,261	\$14,167,285	\$1,239,322	\$0	\$0	\$0	\$45,433,039
Vertical Mine Development	\$2,086,128	\$1,347,715	\$737,955	\$757,306	\$95,549	\$0	\$0	\$0	\$5,024,653
Airleg Escapeway Drives	\$0	\$0	\$0	\$0	\$0	\$0	\$0	\$0	\$0
Plant Ownership (HP)	\$2,238,800	\$2,880,800	\$3,260,800	\$3,651,800	\$3,928,800	\$2,978,800	\$2,249,000	\$0	\$21,188,800
Escapeway Ladders	\$420,000	\$88,000	\$158,000	\$228,000	\$78,000	\$0	\$0	\$0	\$972,000
Site Construction	\$2,934,000	\$0	\$0	\$0	\$0	\$0	\$0	\$0	\$2,934,000
Site Establishment	\$335,000	\$0	\$0	\$0	\$0	\$0	\$0	\$0	\$335,000
Site Fuel	\$135,000	\$0	\$0	\$0	\$0	\$0	\$0	\$0	\$135,000
Compressed Air	\$244,976	\$0	\$0	\$0	\$0	\$0	\$0	\$0	\$244,976
Mining Tools	\$347,700	\$1,015,000	\$0	\$0	\$0	\$0	\$0	\$0	\$1,362,700
HV Electrical	\$1,024,830	\$324,500	\$324,500	\$324,500	\$0	\$0	\$0	\$0	\$1,998,330
LV Electrical	\$1,763,200	\$1,093,750	\$387,400	\$520,950	\$53,550	\$0	\$0	\$0	\$3,818,850
Ventilation	\$688,000	\$1,120,000	\$60,000	\$240,000	\$0	\$0	\$0	\$0	\$2,108,000
Refuge Chambers	\$313,520	\$100,000	\$100,000	\$100,000	\$100,000	\$0	\$0	\$0	\$713,520
UG Water Supply	\$160,000	\$5,000	\$7,500	\$7,500	\$0	\$0	\$0	\$0	\$180,000
Pumping	\$613,448	\$22,900	\$442,900	\$454,350	\$0	\$0	\$0	\$0	\$1,533,598
Surface Workshop Tools	\$15,000	\$0	\$0	\$0	\$0	\$0	\$0	\$0	\$15,000
Explosive Magazine	\$550,000	\$0	\$0	\$0	\$0	\$0	\$0	\$0	\$550,000
Others	\$57,000	\$36,000	\$36,000	\$36,000	\$36,000	\$36,000	\$30,000	\$0	\$267,000
<b>TOTAL (WTS)</b>	<b>\$29,512,939</b>	<b>\$16,135,500</b>	<b>\$11,853,315</b>	<b>\$20,487,692</b>	<b>\$5,531,221</b>	<b>\$3,014,800</b>	<b>\$2,279,000</b>	<b>\$0</b>	<b>\$88,814,466</b>
<b>Gillett &amp; Widgie 3 (GW3)</b>									
Lateral Mine Development	\$19,236,011	\$28,936,195	\$8,719,060	\$741,810	\$0	\$0	\$0	\$0	\$57,633,075
Vertical Mine Development	\$1,991,926	\$4,136,848	\$2,054,283	\$57,399	\$0	\$0	\$0	\$0	\$8,240,456

# Standalone Mt Edwards Project Scoping Study Highlights Nickel Potential

7 March 2024



Airleg Escapeway Drives	\$0	\$0	\$0	\$0	\$0	\$0	\$0	\$0	\$0
Plant Ownership (HP)	\$3,006,500	\$5,287,000	\$5,653,000	\$4,378,000	\$3,636,000	\$2,678,000	\$2,478,000	\$2,065,000	\$29,181,500
Escapeway Ladders	\$276,000	\$874,000	\$642,000	\$138,000	\$0	\$0	\$0	\$0	\$1,930,000
Site Construction	\$838,000	\$0	\$0	\$0	\$0	\$0	\$0	\$0	\$838,000
Site Establishment	\$85,000	\$0	\$0	\$0	\$0	\$0	\$0	\$0	\$85,000
Site Fuel	\$135,000	\$0	\$0	\$0	\$0	\$0	\$0	\$0	\$135,000
Compressed Air	\$244,976	\$0	\$0	\$0	\$0	\$0	\$0	\$0	\$244,976
Mining Tools	\$407,280	\$900,000	\$0	\$0	\$0	\$0	\$0	\$0	\$1,307,280
HV Electrical	\$1,828,000	\$1,093,500	\$649,000	\$0	\$0	\$0	\$0	\$0	\$3,570,500
LV Electrical	\$2,924,200	\$4,206,150	\$1,518,000	\$40,000	\$0	\$0	\$0	\$0	\$8,688,350
Ventilation	\$1,913,000	\$825,000	\$550,000	\$90,000	\$0	\$0	\$0	\$0	\$3,378,000
Refuge Chambers	\$413,520	\$300,000	\$200,000	\$200,000	\$0	\$0	\$0	\$0	\$1,113,520
UG Water Supply	\$160,000	\$10,000	\$12,500	\$2,500	\$0	\$0	\$0	\$0	\$185,000
Pumping	\$579,616	\$1,191,810	\$680,240	\$60,240	\$0	\$0	\$0	\$0	\$2,511,906
Surface Workshop Tools	\$0	\$0	\$0	\$0	\$0	\$0	\$0	\$0	\$0
Explosive Magazine	\$50,000	\$0	\$0	\$0	\$0	\$0	\$0	\$0	\$50,000
Others	\$57,000	\$36,000	\$36,000	\$36,000	\$36,000	\$36,000	\$36,000	\$30,000	\$303,000
<b>TOTAL (GW3)</b>	<b>\$34,146,029</b>	<b>\$47,796,502</b>	<b>\$20,714,083</b>	<b>\$5,743,950</b>	<b>\$3,672,000</b>	<b>\$2,714,000</b>	<b>\$2,514,000</b>	<b>\$2,095,000</b>	<b>\$119,395,563</b>
<b>Armstrong (ANM)</b>									
Lateral Mine Development	\$0	\$0	\$0	\$0	\$11,705,914	\$1,083,055	\$0	\$0	\$12,788,969
Vertical Mine Development	\$0	\$0	\$0	\$0	\$927,100	\$134,400	\$0	\$0	\$1,061,500
Airleg Escapeway Drives	\$0	\$0	\$0	\$0	\$26,700	\$0	\$0	\$0	\$26,700
Plant Ownership (HP)	\$0	\$0	\$0	\$0	\$2,205,200	\$2,508,200	\$2,665,200	\$405,300	\$7,783,900
Escapeway Ladders	\$0	\$0	\$0	\$0	\$282,000	\$108,000	\$0	\$0	\$390,000
Site Construction	\$0	\$0	\$0	\$0	\$2,325,270	\$0	\$0	\$0	\$2,325,270
Site Establishment	\$0	\$0	\$0	\$0	\$225,000	\$0	\$0	\$0	\$225,000
Site Fuel	\$0	\$0	\$0	\$0	\$135,000	\$0	\$0	\$0	\$135,000
Compressed Air	\$0	\$0	\$0	\$0	\$244,976	\$0	\$0	\$0	\$244,976
Mining Tools	\$0	\$0	\$0	\$0	\$347,700	\$1,015,000	\$0	\$0	\$1,362,700
HV Electrical	\$0	\$0	\$0	\$0	\$724,828	\$0	\$0	\$0	\$724,828
LV Electrical	\$0	\$0	\$0	\$0	\$1,872,100	\$198,300	\$0	\$0	\$2,070,400
Ventilation	\$0	\$0	\$0	\$0	\$802,000	\$0	\$0	\$0	\$802,000
Refuge Chambers	\$0	\$0	\$0	\$0	\$348,360	\$0	\$0	\$0	\$348,360
UG Water Supply	\$0	\$0	\$0	\$0	\$160,000	\$2,500	\$0	\$0	\$162,500
Pumping	\$0	\$0	\$0	\$0	\$533,846	\$34,350	\$0	\$0	\$568,196
Surface Workshop Tools	\$0	\$0	\$0	\$0	\$15,000	\$0	\$0	\$0	\$15,000
Explosive Magazine	\$0	\$0	\$0	\$0	\$300,000	\$0	\$0	\$0	\$300,000
Others	\$0	\$0	\$0	\$0	\$57,000	\$36,000	\$36,000	\$9,000	\$138,000
<b>TOTAL (ANM)</b>	<b>\$0</b>	<b>\$0</b>	<b>\$0</b>	<b>\$0</b>	<b>\$23,237,994</b>	<b>\$5,119,805</b>	<b>\$2,701,200</b>	<b>\$414,300</b>	<b>\$31,473,299</b>
<b>132N (132N)</b>									
Lateral Mine Development	\$0	\$0	\$0	\$0	\$2,240,465	\$16,248,421	\$4,440,823	\$0	\$22,929,709
Vertical Mine Development	\$0	\$0	\$0	\$0	\$0	\$1,461,130	\$465,976	\$0	\$1,927,106
Airleg Escapeway Drives	\$0	\$0	\$0	\$0	\$0	\$0	\$0	\$0	\$0

# Standalone Mt Edwards Project Scoping Study Highlights Nickel Potential

7 March 2024

Plant Ownership (HP)	\$0	\$0	\$0	\$0	\$334,200	\$2,245,200	\$2,901,200	\$1,949,000	\$7,429,600
Escapeway Ladders	\$0	\$0	\$0	\$0	\$0	\$354,000	\$220,000	\$0	\$574,000
Site Construction	\$0	\$0	\$0	\$0	\$1,330,720	\$0	\$0	\$0	\$1,330,720
Site Establishment	\$0	\$0	\$0	\$0	\$80,000	\$5,000	\$0	\$0	\$85,000
Site Fuel	\$0	\$0	\$0	\$0	\$135,000	\$0	\$0	\$0	\$135,000
Compressed Air	\$0	\$0	\$0	\$0	\$147,988	\$96,988	\$0	\$0	\$244,976
Mining Tools	\$0	\$0	\$0	\$0	\$193,830	\$0	\$0	\$0	\$193,830
HV Electrical	\$0	\$0	\$0	\$0	\$275,500	\$325,498	\$0	\$0	\$600,998
LV Electrical	\$0	\$0	\$0	\$0	\$145,100	\$1,597,350	\$210,000	\$0	\$1,952,450
Ventilation	\$0	\$0	\$0	\$0	\$72,000	\$537,000	\$15,000	\$0	\$624,000
Refuge Chambers	\$0	\$0	\$0	\$0	\$79,260	\$269,100	\$0	\$0	\$348,360
UG Water Supply	\$0	\$0	\$0	\$0	\$152,500	\$7,500	\$2,500	\$0	\$162,500
Pumping	\$0	\$0	\$0	\$0	\$123,576	\$433,170	\$11,450	\$0	\$568,196
Surface Workshop Tools	\$0	\$0	\$0	\$0	\$15,000	\$0	\$0	\$0	\$15,000
Explosive Magazine	\$0	\$0	\$0	\$0	\$0	\$50,000	\$0	\$0	\$50,000
Others	\$0	\$0	\$0	\$0	\$20,000	\$43,000	\$36,000	\$30,000	\$129,000
<b>TOTAL (132N)</b>	<b>\$0</b>	<b>\$0</b>	<b>\$0</b>	<b>\$0</b>	<b>\$5,345,139</b>	<b>\$23,673,357</b>	<b>\$8,302,949</b>	<b>\$1,979,000</b>	<b>\$39,300,445</b>

**Table 38 - Total Direct Mining Cost Summary**

YEAR	Year 1	Year 2	Year 3	Year 4	Year 5	Year 6	Year 7	Year 8	TOTAL
<b>Mine Ore Production (t)</b>									
WTS	26,761	265,752	364,987	359,999	341,999	225,686	137,606	0	1,722,791
GW3	10,407	152,678	427,553	479,485	460,922	368,277	252,000	184,726	2,336,047
ANM	28,710	0	0	0	10,650	218,153	270288	46374	574,175
132N	0	0	0	0	0	0	174,850	239692	414,542
<b>TOTAL ORE PRODUCTION (t)</b>	<b>65,878</b>	<b>418,430</b>	<b>792,540</b>	<b>839,484</b>	<b>813,571</b>	<b>812,116</b>	<b>834,744</b>	<b>470,792</b>	<b>5,047,555</b>
<b>RAW MINING OPERATING COSTS</b>									
WTS	\$3,891,096	\$28,485,141	\$32,411,297	\$27,437,877	\$34,470,357	\$25,339,564	\$15,953,233	\$0	\$167,988,566
GW3	\$3,149,238	\$17,084,260	\$46,038,166	\$43,513,694	\$37,567,237	\$27,898,720	\$22,173,984	\$19,413,528	\$216,838,828
ANM	\$0	\$0	\$0	\$0	\$7,508,038	\$26,732,616	\$21,878,392	\$4,217,792	\$60,336,838
132N	\$0	\$0	\$0	\$0	\$0	\$3,068,073	\$22,613,021	\$19,590,432	\$45,271,526
<b>SUB TOTAL</b>	<b>\$7,040,334</b>	<b>\$45,569,401</b>	<b>\$78,449,463</b>	<b>\$70,951,571</b>	<b>\$79,545,632</b>	<b>\$83,038,974</b>	<b>\$82,618,630</b>	<b>\$43,221,752</b>	<b>\$490,435,758</b>
<b>RAW MINING CAPITAL COSTS</b>									
WTS	\$29,532,939	\$16,135,500	\$11,873,315	\$20,507,692	\$5,531,221	\$3,014,800	\$2,279,000	\$0	\$88,874,466
GW3	\$34,146,029	\$47,796,502	\$20,714,083	\$5,743,950	\$3,672,000	\$2,714,000	\$2,514,000	\$2,095,000	\$119,395,563
ANM	\$0	\$0	\$0	\$0	\$23,237,994	\$5,119,805	\$2,701,200	\$414,300	\$31,473,299
132N	\$0	\$0	\$0	\$0	\$5,345,139	\$23,673,357	\$8,302,949	\$1,979,000	\$39,300,445
<b>SUB TOTAL</b>	<b>\$63,678,967</b>	<b>\$63,932,002</b>	<b>\$32,587,398</b>	<b>\$26,251,641</b>	<b>\$37,786,353</b>	<b>\$34,521,962</b>	<b>\$15,797,149</b>	<b>\$4,488,300</b>	<b>\$279,043,773</b>
<b>RAW MINING TOTAL COSTS</b>									
WTS	\$33,424,035	\$44,620,641	\$44,284,613	\$47,945,568	\$40,001,578	\$28,354,364	\$18,232,233	\$0	\$256,863,032
GW3	\$37,295,267	\$64,880,762	\$66,752,249	\$49,257,644	\$41,239,237	\$30,612,720	\$24,687,984	\$21,508,528	\$336,234,391
ANM	\$0	\$0	\$0	\$0	\$30,746,032	\$31,852,422	\$24,579,592	\$4,632,092	\$91,810,137
132N	\$0	\$0	\$0	\$0	\$5,345,139	\$26,741,431	\$30,915,970	\$21,569,432	\$84,571,971
<b>TOTAL</b>	<b>\$70,719,302</b>	<b>\$109,501,403</b>	<b>\$111,036,862</b>	<b>\$97,203,212</b>	<b>\$117,331,986</b>	<b>\$117,560,937</b>	<b>\$98,415,779</b>	<b>\$47,710,052</b>	<b>\$769,479,532</b>
<b>RAW MINING UNIT OP COSTS</b>									
WTS	\$145	\$107	\$89	\$76	\$101	\$112	\$116	\$0	\$98
GW3	\$303	\$112	\$108	\$91	\$82	\$76	\$88	\$105	\$93
ANM	\$0	\$0	\$0	\$0	\$705	\$123	\$81	\$91	\$105
132N	\$0	\$0	\$0	\$0	\$0	\$0	\$129	\$82	\$109
<b>TOTAL</b>	<b>\$107</b>	<b>\$109</b>	<b>\$99</b>	<b>\$85</b>	<b>\$98</b>	<b>\$102</b>	<b>\$99</b>	<b>\$92</b>	<b>\$97</b>
<b>RAW MINING UNIT TOTAL COSTS</b>									
WTS	\$1,249	\$168	\$121	\$133	\$117	\$126	\$132	\$0	\$149

# Standalone Mt Edwards Project Scoping Study Highlights Nickel Potential

7 March 2024

GW3	\$3,584	\$425	\$156	\$103	\$89	\$83	\$98	\$116	\$144
ANM	\$0	\$0	\$0	\$0	\$2,887	\$146	\$91	\$100	\$160
132N	\$0	\$0	\$0	\$0	\$0	\$0	\$177	\$90	\$204
<b>TOTAL</b>	<b>\$1,073</b>	<b>\$262</b>	<b>\$140</b>	<b>\$116</b>	<b>\$144</b>	<b>\$145</b>	<b>\$118</b>	<b>\$101</b>	<b>\$152</b>

## Mine Tech Services Costs

These are the cost associated with mine management and technical services functions to support the direct mining operations. These include wages/salaries for support staff, mines rescue coverage, office items, computer items, light vehicles, and other required equipment.

**Table 39 - Tech Services Unit Cost Summary**

YEAR	Year 1	Year 2	Year 3	Year 4	Year 5	Year 6	Year 7	Year 8	TOTAL
Mine Ore Production (t)	65,878	418,430	792,540	839,484	813,571	812,116	834,744	470,792	<b>5,047,555</b>
<b>Total Operating Costs</b>	<b>\$2,372,770</b>	<b>\$3,551,210</b>	<b>\$3,772,693</b>	<b>\$3,762,470</b>	<b>\$5,288,582</b>	<b>\$5,656,319</b>	<b>\$5,633,479</b>	<b>\$3,809,011</b>	<b>\$33,846,536</b>
<b>Total Capital Costs</b>	<b>\$383,500</b>	<b>\$18,000</b>	<b>\$18,000</b>	<b>\$18,000</b>	<b>\$301,500</b>	<b>\$36,000</b>	<b>\$49,500</b>	<b>\$19,500</b>	<b>\$844,000</b>
<b>Total Costs</b>	<b>\$2,756,270</b>	<b>\$3,569,210</b>	<b>\$3,790,693</b>	<b>\$3,780,470</b>	<b>\$5,590,082</b>	<b>\$5,692,319</b>	<b>\$5,682,979</b>	<b>\$3,828,511</b>	<b>\$34,690,536</b>
<b>Tech Services Unit Costs</b>									
Operating Unit Cost (\$/t Mined)	\$36.02	\$8.49	\$4.76	\$4.48	\$6.50	\$6.96	\$6.75	\$8.09	<b>\$6.71</b>
Total Unit Cost (\$/t Mined)	\$41.84	\$8.53	\$4.78	\$4.50	\$6.87	\$7.01	\$6.81	\$8.13	<b>\$6.87</b>

**Table 40 - Tech Services Site Cost Summary**

YEAR	Year 1	Year 2	Year 3	Year 4	Year 5	Year 6	Year 7	Year 8	TOTAL
<b>Fixed Tech Services Costs</b>									
<b>Staff Wages</b>									
WTS	\$1,704,375	\$1,876,500	\$1,876,500	\$1,876,500	\$1,876,500	\$1,876,500	\$1,876,500	\$0	<b>\$12,963,375</b>
GW3	\$0	\$405,000	\$810,000	\$810,000	\$810,000	\$810,000	\$810,000	\$238,500	<b>\$4,693,500</b>
ANM	\$0	\$0	\$1,218,375	\$1,755,000	\$1,917,000	\$367,875	\$0	\$0	<b>\$5,258,250</b>
132N	\$0	\$0	\$0	\$0	\$0	\$1,437,750	\$1,917,000	\$0	<b>\$3,354,750</b>
<b>SUBTOTAL</b>	<b>\$1,704,375</b>	<b>\$2,281,500</b>	<b>\$3,904,875</b>	<b>\$4,441,500</b>	<b>\$4,603,500</b>	<b>\$4,492,125</b>	<b>\$4,603,500</b>	<b>\$238,500</b>	<b>\$26,269,875</b>
<b>LV Ownership</b>									
WTS	\$144,000	\$144,000	\$144,000	\$144,000	\$144,000	\$144,000	\$144,000	\$0	<b>\$1,008,000</b>
GW3	\$0	\$30,000	\$60,000	\$60,000	\$60,000	\$60,000	\$60,000	\$10,000	<b>\$340,000</b>
ANM	\$0	\$0	\$144,000	\$144,000	\$144,000	\$36,000	\$0	\$0	<b>\$468,000</b>
132N	\$0	\$0	\$0	\$0	\$0	\$108,000	\$144,000	\$0	<b>\$252,000</b>
<b>SUBTOTAL</b>	<b>\$144,000</b>	<b>\$174,000</b>	<b>\$348,000</b>	<b>\$348,000</b>	<b>\$348,000</b>	<b>\$348,000</b>	<b>\$348,000</b>	<b>\$10,000</b>	<b>\$2,068,000</b>

# Standalone Mt Edwards Project Scoping Study Highlights Nickel Potential

7 March 2024

<b>Mines Rescue Coverage</b>									
WTS	\$60,000	\$60,000	\$60,000	\$60,000	\$60,000	\$60,000	\$60,000	\$0	<b>\$420,000</b>
GW3	\$60,000	\$60,000	\$60,000	\$60,000	\$60,000	\$60,000	\$60,000	\$10,000	<b>\$430,000</b>
ANM	\$0	\$0	\$60,000	\$60,000	\$60,000	\$15,000	\$0	\$0	<b>\$195,000</b>
132N	\$0	\$0	\$0	\$0	\$60,000	\$60,000	\$60,000	\$0	<b>\$180,000</b>
<b>SUBTOTAL</b>	<b>\$120,000</b>	<b>\$120,000</b>	<b>\$180,000</b>	<b>\$180,000</b>	<b>\$240,000</b>	<b>\$195,000</b>	<b>\$180,000</b>	<b>\$10,000</b>	<b>\$1,225,000</b>
<b>TOTAL FIXED COSTS</b>	<b>\$1,968,375</b>	<b>\$2,575,500</b>	<b>\$4,432,875</b>	<b>\$4,969,500</b>	<b>\$5,191,500</b>	<b>\$5,035,125</b>	<b>\$5,131,500</b>	<b>\$258,500</b>	<b>\$29,562,875</b>
<b>Variable Tech Services Costs</b>									
<b>Others</b>									
WTS	\$208,818	\$165,702	\$151,410	\$164,245	\$164,012	\$141,900	\$138,158	\$0	<b>\$1,134,246</b>
GW3	\$14,329	\$49,150	\$52,228	\$18,457	\$27,972	\$8,200	\$10,321	\$2,899	<b>\$183,556</b>
ANM	\$0	\$0	\$203,850	\$153,402	\$142,532	\$26,097	\$0	\$0	<b>\$525,881</b>
132	\$0	\$0	\$0	\$0	\$0	\$117,887	\$147,451	\$0	<b>\$265,338</b>
<b>SUBTOTAL</b>	<b>\$223,146</b>	<b>\$214,852</b>	<b>\$407,489</b>	<b>\$336,105</b>	<b>\$334,517</b>	<b>\$294,084</b>	<b>\$295,929</b>	<b>\$2,899</b>	<b>\$2,109,021</b>
<b>Light Vehicle Maintenance</b>									
WTS	\$81,600	\$81,600	\$81,600	\$81,600	\$81,600	\$81,600	\$81,600	\$0	<b>\$571,200</b>
GW3	\$0	\$20,400	\$40,800	\$40,800	\$40,800	\$40,800	\$40,800	\$6,800	<b>\$231,200</b>
ANM	\$0	\$0	\$81,600	\$81,600	\$81,600	\$20,400	\$0	\$0	<b>\$265,200</b>
132N	\$0	\$0	\$0	\$0	\$0	\$61,200	\$81,600	\$0	<b>\$142,800</b>
<b>SUBTOTAL</b>	<b>\$81,600</b>	<b>\$102,000</b>	<b>\$204,000</b>	<b>\$204,000</b>	<b>\$204,000</b>	<b>\$204,000</b>	<b>\$204,000</b>	<b>\$6,800</b>	<b>\$1,210,400</b>
<b>Diesel</b>									
WTS	\$39,231	\$39,231	\$39,231	\$39,231	\$39,231	\$39,231	\$39,231	\$0	<b>\$274,615</b>
GW3	\$0	\$9,808	\$19,615	\$19,615	\$19,615	\$19,615	\$19,615	\$3,269	<b>\$111,154</b>
ANM	\$0	\$0	\$39,231	\$39,231	\$39,231	\$9,808	\$0	\$0	<b>\$127,500</b>
132N	\$0	\$0	\$0	\$0	\$0	\$29,423	\$39,231	\$0	<b>\$68,654</b>
<b>Rebate</b>	<b>\$9,731</b>	<b>\$12,164</b>	<b>\$24,327</b>	<b>\$24,327</b>	<b>\$24,327</b>	<b>\$24,327</b>	<b>\$24,327</b>	<b>\$811</b>	<b>\$144,340</b>
<b>SUBTOTAL</b>	<b>\$29,500</b>	<b>\$36,875</b>	<b>\$73,750</b>	<b>\$73,750</b>	<b>\$73,750</b>	<b>\$73,750</b>	<b>\$73,750</b>	<b>\$2,458</b>	<b>\$437,583</b>
<b>TOTAL VARIABLE COSTS</b>	<b>\$334,246</b>	<b>\$353,727</b>	<b>\$685,239</b>	<b>\$613,855</b>	<b>\$612,267</b>	<b>\$571,834</b>	<b>\$573,679</b>	<b>\$12,157</b>	<b>\$3,757,003</b>
<b>Tech Services Capital Costs</b>									
Survey Equipment	\$250,000	\$0	\$150,000	\$0	\$0	\$0	\$0	\$0	<b>\$400,000</b>
Geology Equipment	\$25,000	\$0	\$25,000	\$0	\$0	\$0	\$0	\$0	<b>\$50,000</b>
Office PCs	\$50,000	\$0	\$50,000	\$0	\$0	\$0	\$0	\$0	<b>\$100,000</b>
Office Furniture	\$15,000	\$0	\$15,000	\$0	\$0	\$0	\$0	\$0	<b>\$30,000</b>
Miscellaneous	\$43,500	\$18,000	\$61,500	\$36,000	\$36,000	\$36,000	\$36,000	\$0	<b>\$267,000</b>
<b>TOTAL CAPITAL</b>	<b>\$383,500</b>	<b>\$18,000</b>	<b>\$301,500</b>	<b>\$36,000</b>	<b>\$36,000</b>	<b>\$36,000</b>	<b>\$36,000</b>	<b>\$0</b>	<b>\$847,000</b>

## Milling and Ore Cartage Costs

These are the cost associated with processing the ore to concentrate including carting the ore from the individual site ROM pads to the mill.

**Table 41 - Milling & Ore Cartage Cost Summary**

YEAR	Year 1	Year 2	Year 3	Year 4	Year 5	Year 6	Year 7	Year 8	TOTAL
<b>FIXED MILLING COSTS</b>									
Manpower Wages	\$0	\$6,435,000	\$8,580,000	\$8,580,000	\$8,580,000	\$8,580,000	\$8,580,000	\$7,150,000	<b>\$56,485,000</b>
Mobile Plant Ownership	\$0	\$837,000	\$1,116,000	\$1,116,000	\$1,116,000	\$1,116,000	\$1,116,000	\$930,000	<b>\$7,347,000</b>
Mill Operation	\$0	\$76,500	\$102,000	\$102,000	\$102,000	\$102,000	\$102,000	\$85,000	<b>\$671,500</b>
Services	\$0	\$153,000	\$204,000	\$204,000	\$204,000	\$204,000	\$204,000	\$170,000	<b>\$1,343,000</b>
<b>SUB TOTAL</b>	<b>\$0</b>	<b>\$7,501,500</b>	<b>\$10,002,000</b>	<b>\$10,002,000</b>	<b>\$10,002,000</b>	<b>\$10,002,000</b>	<b>\$10,002,000</b>	<b>\$8,335,000</b>	<b>\$65,846,500</b>
<b>VARIABLE MILLING COSTS</b>									
Mobile Machines Material Parts	\$0	\$427,500	\$570,000	\$570,000	\$570,000	\$570,000	\$570,000	\$475,000	<b>\$3,752,500</b>
Lab Items	\$0	\$220,800	\$349,600	\$368,000	\$368,000	\$368,000	\$368,000	\$279,476	<b>\$2,321,876</b>
Reagent Consumables	\$0	\$830,880	\$1,315,560	\$1,384,800	\$1,384,800	\$1,384,800	\$1,384,800	\$1,051,680	<b>\$8,737,320</b>
Environmental	\$0	\$58,500	\$78,000	\$78,000	\$78,000	\$78,000	\$78,000	\$65,000	<b>\$513,500</b>
Crushing & Grinding Consumables	\$0	\$1,597,500	\$2,752,500	\$2,842,500	\$2,842,500	\$2,842,500	\$2,842,500	\$1,932,001	<b>\$17,652,001</b>
Misc Milling Costs	\$0	\$915,705	\$1,418,963	\$1,564,724	\$1,521,031	\$1,666,776	\$1,617,148	\$1,208,941	<b>\$9,913,288</b>
Diesel Consumption	\$36,710	\$336,950	\$599,033	\$632,991	\$617,608	\$618,321	\$630,350	\$391,757	<b>\$3,863,721</b>
General Maintenance	\$0	\$234,000	\$312,000	\$312,000	\$312,000	\$312,000	\$312,000	\$260,000	<b>\$2,054,000</b>
Crusher Maintenance	\$0	\$1,165,500	\$1,554,000	\$1,554,000	\$1,554,000	\$1,554,000	\$1,554,000	\$1,295,000	<b>\$10,230,500</b>
Misc Maintenance Costs	\$0	\$612,000	\$816,000	\$816,000	\$816,000	\$816,000	\$816,000	\$680,000	<b>\$5,372,000</b>
<b>SUB TOTAL</b>	<b>\$36,710</b>	<b>\$6,399,335</b>	<b>\$9,765,656</b>	<b>\$10,123,015</b>	<b>\$10,063,939</b>	<b>\$10,210,397</b>	<b>\$10,172,798</b>	<b>\$7,638,855</b>	<b>\$64,410,707</b>
<b>MILLING CAPITAL COSTS</b>									
Office Furniture	\$0.00	\$30,000.00	\$0.00	\$0.00	\$0.00	\$0.00	\$0.00	\$0.00	<b>\$30,000</b>
Computers	\$0.00	\$80,000.00	\$0.00	\$0.00	\$0.00	\$0.00	\$0.00	\$0.00	<b>\$80,000</b>
Ongoing Process Plant Capital	\$0.00	\$135,000.00	\$180,000.00	\$180,000.00	\$180,000.00	\$180,000.00	\$180,000.00	\$150,000.00	<b>\$1,185,000</b>
<b>SUB TOTAL</b>	<b>\$0</b>	<b>\$245,000</b>	<b>\$180,000</b>	<b>\$180,000</b>	<b>\$180,000</b>	<b>\$180,000</b>	<b>\$180,000</b>	<b>\$150,000</b>	<b>\$1,295,000</b>
<b>MILLING COSTS SUMMARY</b>									
<b>Ore Milled (t)</b>	0	480,000	760,000	800,000	800,000	800,000	800,000	607,556	<b>5,047,556</b>
Fixed costs (operational)	\$0	\$7,501,500	\$10,002,000	\$10,002,000	\$10,002,000	\$10,002,000	\$10,002,000	\$8,335,000	<b>\$65,846,500</b>
Variable Costs (operational)	\$36,710	\$6,399,335	\$9,765,656	\$10,123,015	\$10,063,939	\$10,210,397	\$10,172,798	\$7,638,855	<b>\$64,410,707</b>
Capital Costs	\$0	\$245,000	\$180,000	\$180,000	\$180,000	\$180,000	\$180,000	\$150,000	<b>\$1,295,000</b>
Operating	\$36,710	\$13,900,835	\$19,767,656	\$20,125,015	\$20,065,939	\$20,212,397	\$20,174,798	\$15,973,855	<b>\$130,257,207</b>
<b>MILLING TOTAL COSTS</b>	<b>\$36,710</b>	<b>\$14,145,835</b>	<b>\$19,947,656</b>	<b>\$20,305,015</b>	<b>\$20,245,939</b>	<b>\$20,392,397</b>	<b>\$20,354,798</b>	<b>\$16,123,855</b>	<b>\$131,552,207</b>
<b>UNIT MILLING COSTS</b>									

# Standalone Mt Edwards Project Scoping Study Highlights Nickel Potential

7 March 2024

Operating Unit Cost (Ex Power) - \$/t	\$0.00	\$28.96	\$26.01	\$25.16	\$25.08	\$25.27	\$25.22	\$26.29	<b>\$25.81</b>
Total Unit Cost (Ex Power) - \$/t	\$0.00	\$29.47	\$26.25	\$25.38	\$25.31	\$25.49	\$25.44	\$26.54	<b>\$26.06</b>
Mill Power Cost	\$0	\$3,921,765	\$6,209,461	\$6,536,275	\$6,536,275	\$6,536,275	\$6,536,275	\$4,963,943	<b>\$41,240,270</b>
Unit Power Cost - \$/t	\$0.00	\$8.17	\$8.17	\$8.17	\$8.17	\$8.17	\$8.17	\$8.17	<b>\$8.17</b>
Operating Unit Cost (Inc Power) - \$/t	\$0.00	\$37.13	\$34.18	\$33.33	\$33.25	\$33.44	\$33.39	\$34.46	<b>\$33.98</b>
Total Unit Cost (Inc Power) - \$/t	\$0.00	\$37.64	\$34.42	\$33.55	\$33.48	\$33.66	\$33.61	\$34.71	<b>\$34.23</b>

Ore Cartage Cost from Site \$2.85/t, Unit Milling Cost (Inc Power, Ex Ore Cartage) = \$31.13/t.

## Surface Infrastructure Costs

These are the cost associated with surface infrastructure construction, maintenance, and power supply. Surface infrastructure includes the process plant, borefield allowance, accommodation village, powerlines/HV infrastructure and roads.



**Table 42 - Surface Infrastructure Cost Summary**

YEAR	Year 1	Year 2	Year 3	Year 4	Year 5	Year 6	Year 7	Year 8	TOTAL
<b>Fixed Surface Infrastructure Costs</b>									
Total Mining Ownership	\$0	\$376,200	\$501,600	\$501,600	\$501,600	\$501,600	\$501,600	\$83,600	<b>\$2,967,800</b>
Total Wages	\$491,400	\$1,822,275	\$2,296,613	\$2,334,150	\$2,334,150	\$2,334,150	\$2,334,150	\$389,025	<b>\$14,335,913</b>
Surface Plant Servicing	\$48,000	\$151,200	\$177,600	\$177,600	\$177,600	\$177,600	\$148,000	\$29,600	<b>\$1,087,200</b>
<b>TOTAL FIXED COSTS</b>	<b>\$539,400</b>	<b>\$2,349,675</b>	<b>\$2,975,813</b>	<b>\$3,013,350</b>	<b>\$3,013,350</b>	<b>\$3,013,350</b>	<b>\$2,983,750</b>	<b>\$502,225</b>	<b>\$18,390,913</b>
<b>Variable Surface Infrastructure Costs</b>									
Total Mobile Plant - Material Parts	\$0	\$149,850	\$199,800	\$199,800	\$199,800	\$199,800	\$199,800	\$33,300	<b>\$1,182,150</b>
Total Fuel Costs	\$0	\$200,239	\$266,985	\$266,985	\$266,985	\$266,985	\$266,985	\$44,498	<b>\$1,579,661</b>
Site Power Costs (No Mining)	\$421,092	\$7,969,009	\$9,311,452	\$10,457,090	\$10,784,416	\$9,966,102	\$9,475,114	\$974,590	<b>\$59,358,865</b>
<b>TOTAL VARIABLE COSTS</b>	<b>\$421,092</b>	<b>\$8,319,097</b>	<b>\$9,778,237</b>	<b>\$10,923,875</b>	<b>\$11,251,201</b>	<b>\$10,432,887</b>	<b>\$9,941,899</b>	<b>\$1,052,387</b>	<b>\$62,120,676</b>
<b>Surface Infrastructure Capital Costs</b>									
<b>Major Items</b>									
Batch Plant	\$1,000,000	\$0	\$0	\$0	\$0	\$0	\$0	\$0	<b>\$1,000,000</b>
Site Roads and Signs	\$750,000	\$750,000	\$0	\$0	\$0	\$0	\$0	\$0	<b>\$1,500,000</b>
Main Road Haulageway Turnout	\$0	\$1,500,000	\$0	\$0	\$0	\$0	\$0	\$0	<b>\$1,500,000</b>
Mill Construction (inc Tails Dam Stage 1, Bore Field)	\$85,000,000	\$26,829,615	\$0	\$0	\$0	\$0	\$0	\$0	<b>\$111,829,615</b>
Tails Dam - Stage 2	\$0	\$0	\$0	\$3,000,000	\$0	\$0	\$0	\$0	<b>\$3,000,000</b>
Camp Construction (250 Rooms)	\$15,000,000	\$0	\$0	\$0	\$0	\$0	\$0	\$0	<b>\$15,000,000</b>
Workshop/Store & Admin (Main)	\$500,000	\$1,500,000	\$0	\$0	\$0	\$0	\$0	\$0	<b>\$2,000,000</b>
Core Yard Facility	\$750,000	\$0	\$0	\$0	\$0	\$0	\$0	\$0	<b>\$750,000</b>
Camp Establishment	\$300,000	\$0	\$0	\$0	\$0	\$0	\$0	\$0	<b>\$300,000</b>
<b>HV Electrics</b>									
Stage 1 - 33kV Site Distribution	\$14,238,282	\$0	\$0	\$0	\$0	\$0	\$0	\$0	<b>\$14,238,282</b>
Stage 2 - Power Line (11kV - 3.6km) - 132N to ANM	\$0	\$1,200,000	\$0	\$0	\$0	\$0	\$0	\$0	<b>\$1,200,000</b>
<b>Miscellaneous</b>									
Ongoing Capital	\$60,000	\$60,000	\$60,000	\$60,000	\$60,000	\$60,000	\$60,000	\$10,000	<b>\$430,000</b>
<b>TOTAL CAPITAL COSTS</b>	<b>\$117,598,282</b>	<b>\$31,839,615</b>	<b>\$60,000</b>	<b>\$3,060,000</b>	<b>\$60,000</b>	<b>\$60,000</b>	<b>\$60,000</b>	<b>\$10,000</b>	<b>\$152,747,897</b>

# Standalone Mt Edwards Project Scoping Study Highlights Nickel Potential

7 March 2024

Surface Infrastructure Cost Summary									
Ore Milled (t)	0	650,000	765,000	870,000	900,000	825,000	780,000	74,588	<b>4,864,588</b>
Fixed costs (operational)	\$539,400	\$2,349,675	\$2,975,813	\$3,013,350	\$3,013,350	\$3,013,350	\$2,983,750	\$502,225	<b>\$18,390,913</b>
Variable Costs (operational)	\$421,092	\$8,319,097	\$9,778,237	\$10,923,875	\$11,251,201	\$10,432,887	\$9,941,899	\$1,052,387	<b>\$62,120,676</b>
Operating	\$960,492	\$10,668,772	\$12,754,049	\$13,937,225	\$14,264,551	\$13,446,237	\$12,925,649	\$1,554,612	<b>\$80,511,588</b>
Capital Costs	\$117,598,282	\$31,839,615	\$60,000	\$3,060,000	\$60,000	\$60,000	\$60,000	\$10,000	<b>\$152,747,897</b>
Surface Infrastructure Total Costs	<b>\$118,558,774</b>	<b>\$42,508,387</b>	<b>\$12,814,049</b>	<b>\$16,997,225</b>	<b>\$14,324,551</b>	<b>\$13,506,237</b>	<b>\$12,985,649</b>	<b>\$1,564,612</b>	<b>\$233,259,486</b>
Surface Infrastructure Unit Costs									
Operating Cost/t milled (incl power Non Mining)	\$0.00	\$16.41	\$16.67	\$16.02	\$15.85	\$16.30	\$16.57	\$20.84	<b>\$16.55</b>
Total Cost/t milled (incl power Non Mining)	\$0.00	\$65.40	\$16.75	\$19.54	\$15.92	\$16.37	\$16.65	\$20.98	<b>\$47.95</b>

## Administration Costs

These are the costs associated with supporting operations and include running the accommodation village, flights for a full FIFO workforce, wages for management staff and other operation administration items.

**Table 43 - Administration Cost Summary**

YEAR	Year 1	Year 2	Year 3	Year 4	Year 5	Year 6	Year 7	Year 8	TOTAL
<b>ADMINISTRATION COSTS</b>									
<b>FIXED</b>									
Light Vehicles	\$122,400	\$122,400	\$122,400	\$122,400	\$122,400	\$122,400	\$122,400	\$102,000	<b>\$958,800</b>
Admin Wages	\$1,651,000	\$1,865,500	\$1,898,000	\$1,898,000	\$1,898,000	\$1,898,000	\$1,898,000	\$1,581,667	<b>\$14,588,167</b>
Camp Fixed Costs	\$600,000	\$600,000	\$600,000	\$600,000	\$600,000	\$600,000	\$600,000	\$500,000	<b>\$4,700,000</b>
Other Costs	\$441,550	\$1,027,250	\$1,036,000	\$1,036,000	\$1,048,000	\$1,048,000	\$991,500	\$855,000	<b>\$7,483,300</b>
<b>SUB TOTAL</b>	<b>\$2,814,950</b>	<b>\$3,615,150</b>	<b>\$3,656,400</b>	<b>\$3,656,400</b>	<b>\$3,668,400</b>	<b>\$3,668,400</b>	<b>\$3,611,900</b>	<b>\$3,038,667</b>	<b>\$27,730,267</b>
<b>VARIABLE</b>									
Accommodation and Messing	\$3,433,853	\$3,024,159	\$3,076,225	\$3,095,787	\$3,621,677	\$3,984,899	\$3,687,776	\$2,329,167	<b>\$26,253,543</b>
Flights	\$3,041,430	\$3,883,740	\$3,949,890	\$3,977,820	\$4,652,550	\$5,118,540	\$4,740,750	\$2,997,330	<b>\$32,362,050</b>
Other Camp Costs	\$7,200	\$26,200	\$30,000	\$30,000	\$30,000	\$30,000	\$30,000	\$25,000	<b>\$208,400</b>
Light Vehicle Parts	\$60,000	\$60,000	\$60,000	\$60,000	\$60,000	\$60,000	\$60,000	\$50,000	<b>\$470,000</b>
Fuel - LV DIESEL	\$20,537	\$20,537	\$20,537	\$20,537	\$20,537	\$20,537	\$20,537	\$17,114	<b>\$160,876</b>
<b>SUB TOTAL</b>	<b>\$6,563,021</b>	<b>\$7,014,636</b>	<b>\$7,136,652</b>	<b>\$7,184,145</b>	<b>\$8,384,765</b>	<b>\$9,213,976</b>	<b>\$8,539,063</b>	<b>\$5,418,611</b>	<b>\$59,454,869</b>
<b>CAPITAL</b>									
Computers	\$50,000	\$0	\$0	\$0	\$0	\$0	\$0	\$0	<b>\$50,000</b>
Office Furniture	\$50,000	\$0	\$0	\$0	\$0	\$0	\$0	\$0	<b>\$50,000</b>
Others	\$12,000	\$12,000	\$12,000	\$12,000	\$12,000	\$12,000	\$12,000	\$2,000	<b>\$86,000</b>
<b>SUB TOTAL</b>	<b>\$112,000</b>	<b>\$12,000</b>	<b>\$12,000</b>	<b>\$12,000</b>	<b>\$12,000</b>	<b>\$12,000</b>	<b>\$12,000</b>	<b>\$2,000</b>	<b>\$186,000</b>
<b>COST SUMMARY</b>									
Ore Milled (t)	0	480,000	760,000	800,000	800,000	800,000	800,000	607,556	<b>5,047,556</b>
Fixed costs (operational)	\$2,814,950	\$3,615,150	\$3,656,400	\$3,656,400	\$3,668,400	\$3,668,400	\$3,611,900	\$3,038,667	<b>\$27,730,267</b>
Variable Costs (operational)	\$6,563,021	\$7,014,636	\$7,136,652	\$7,184,145	\$8,384,765	\$9,213,976	\$8,539,063	\$5,418,611	<b>\$59,454,869</b>
Capital Costs	\$112,000	\$12,000	\$12,000	\$12,000	\$12,000	\$12,000	\$12,000	\$2,000	<b>\$186,000</b>
Operating	\$9,377,971	\$10,629,786	\$10,793,052	\$10,840,545	\$12,053,165	\$12,882,376	\$12,150,963	\$8,457,278	<b>\$87,185,136</b>
<b>TOTAL COSTS</b>	<b>\$9,489,971</b>	<b>\$10,641,786</b>	<b>\$10,805,052</b>	<b>\$10,852,545</b>	<b>\$12,065,165</b>	<b>\$12,894,376</b>	<b>\$12,162,963</b>	<b>\$8,459,278</b>	<b>\$87,371,136</b>
Operating Unit Cost (\$/t) - Milled	\$0.00	\$22.15	\$14.20	\$13.55	\$15.07	\$16.10	\$15.19	\$13.92	<b>\$17.27</b>
Total Unit Cost (\$/t) - Milled	\$0.00	\$22.17	\$14.22	\$13.57	\$15.08	\$16.12	\$15.20	\$13.92	<b>\$17.31</b>

## Total Operation Cost Summary

These are the total onsite costs for the operation and do not include past mine gate costs such as concentrate transport, concentrate offtake, royalty costs or tax.

**Table 44 - Total Operation Cost Summary**

ITEM	Year 1	Year 2	Year 3	Year 4	Year 5	Year 6	Year 7	Year 8	TOTAL
<b>MINE ORE PRODUCTION</b>									
Total Ore Tonnes (t)	65,878	418,430	792,540	839,484	813,571	812,116	834,744	470,792	<b>5,047,555</b>
Ore Grade Ni (%)	1.28	1.55	1.48	1.55	1.51	1.67	1.64	1.54	<b>1.56</b>
<b>MILL PRODUCTION</b>									
Ore Milled Tonnes (t)	0	480,000	760,000	800,000	800,000	800,000	800,000	607,556	<b>5,047,556</b>
<b>CONCENTRATE DELIVERIES</b>									
Concentrate Deliveries (dmt)	0	50,000	84,500	100,500	94,000	104,500	100,500	82,668	<b>616,668</b>
Ore Grade Ni (%)	0	10.1	10.1	10.1	10.1	10.1	10.1	10.1	<b>10.1</b>
Ore Grade Cu (ppm)	0	13,172	13,603	14,454	14,719	13,232	12,166	10,967	<b>13,226</b>
Ore Grade Co (ppm)	0	2,759	2,649	2,736	2,919	2,586	2,216	1,843	<b>2,524</b>
Ore Grade Au (ppm)	0	0.64	0.62	0.45	0.44	0.54	0.72	0.75	<b>0.59</b>
Ore Grade Pd (ppm)	0	1.99	2.19	1.61	1.36	1.54	1.65	1.34	<b>1.64</b>
Ore Grade Pt (ppm)	0	0.56	0.54	0.42	0.40	0.44	0.45	0.37	<b>0.45</b>
<b>Cost Summary</b>									
<b>RAW MINING COSTS</b>									
Underground Mining Capital	\$63,678,967	\$63,932,002	\$32,587,398	\$26,251,641	\$37,786,353	\$34,521,962	\$15,797,149	\$4,488,300	<b>\$279,043,773</b>
Underground Mining Operating	\$7,040,334	\$45,569,401	\$78,449,463	\$70,951,571	\$79,545,632	\$83,038,974	\$82,618,630	\$43,221,752	<b>\$490,435,758</b>
<b>SUB TOTAL</b>	<b>\$70,719,302</b>	<b>\$109,501,403</b>	<b>\$111,036,862</b>	<b>\$97,203,212</b>	<b>\$117,331,986</b>	<b>\$117,560,937</b>	<b>\$98,415,779</b>	<b>\$47,710,052</b>	<b>\$769,479,532</b>
<b>WIN TECH SERVICES COSTS</b>									
Capital	\$383,500	\$18,000	\$18,000	\$18,000	\$301,500	\$36,000	\$49,500	19500	<b>\$844,000</b>
Operating	\$2,372,770	\$3,551,210	\$3,772,693	\$3,762,470	\$5,288,582	\$5,656,319	\$5,633,479	\$3,809,011	<b>\$33,846,536</b>
<b>SUB TOTAL</b>	<b>\$2,756,270</b>	<b>\$3,569,210</b>	<b>\$3,790,693</b>	<b>\$3,780,470</b>	<b>\$5,590,082</b>	<b>\$5,692,319</b>	<b>\$5,682,979</b>	<b>\$3,828,511</b>	<b>\$34,690,536</b>
<b>MILLING COSTS</b>									
Capital	\$0	\$245,000	\$180,000	\$180,000	\$180,000	\$180,000	\$180,000	\$150,000	<b>\$1,295,000</b>
Operating	\$36,710	\$13,900,835	\$19,767,656	\$20,125,015	\$20,065,939	\$20,212,397	\$20,174,798	\$15,973,855	<b>\$130,257,207</b>
<b>SUB TOTAL</b>	<b>\$36,710</b>	<b>\$14,145,835</b>	<b>\$19,947,656</b>	<b>\$20,305,015</b>	<b>\$20,245,939</b>	<b>\$20,392,397</b>	<b>\$20,354,798</b>	<b>\$16,123,855</b>	<b>\$131,552,207</b>
<b>SURFACE INFRASTRUCTURE</b>									
Capital	\$117,598,282	\$29,710,000	\$60,000	\$4,260,000	\$60,000	\$60,000	\$60,000	\$50,000	<b>\$151,858,282</b>

# Standalone Mt Edwards Project Scoping Study Highlights Nickel Potential

7 March 2024

Operating	\$960,492	\$7,498,489	\$10,616,715	\$10,981,066	\$10,981,066	\$10,981,066	\$10,951,466	\$8,024,831	<b>\$70,995,192</b>
<b>SUB TOTAL</b>	<b>\$118,558,774</b>	<b>\$37,208,489</b>	<b>\$10,676,715</b>	<b>\$15,241,066</b>	<b>\$11,041,066</b>	<b>\$11,041,066</b>	<b>\$11,011,466</b>	<b>\$8,074,831</b>	<b>\$222,853,474</b>
<b>ADMINISTRATION COSTS</b>									
Capital	\$112,000	\$12,000	\$12,000	\$12,000	\$12,000	\$12,000	\$12,000	\$2,000	<b>\$186,000</b>
Operating	\$9,377,971	\$10,629,786	\$10,793,052	\$10,840,545	\$12,053,165	\$12,882,376	\$12,150,963	\$8,457,278	<b>\$87,185,136</b>
<b>SUB TOTAL</b>	<b>\$9,489,971</b>	<b>\$10,641,786</b>	<b>\$10,805,052</b>	<b>\$10,852,545</b>	<b>\$12,065,165</b>	<b>\$12,894,376</b>	<b>\$12,162,963</b>	<b>\$8,459,278</b>	<b>\$87,371,136</b>
<b>TOTAL PROJECT COSTS</b>									
Capital	\$181,772,749	\$93,917,002	\$32,857,398	\$30,721,641	\$38,339,853	\$34,809,962	\$16,098,649	\$4,709,800	<b>\$433,227,055</b>
Operating	\$19,788,277	\$81,149,721	\$123,399,580	\$116,660,668	\$127,934,385	\$132,771,133	\$131,529,337	\$79,486,727	<b>\$812,719,828</b>
<b>TOTAL COSTS</b>	<b>\$201,561,027</b>	<b>\$175,066,723</b>	<b>\$156,256,979</b>	<b>\$147,382,309</b>	<b>\$166,274,238</b>	<b>\$167,581,095</b>	<b>\$147,627,986</b>	<b>\$84,196,527</b>	<b>\$1,245,946,884</b>
<b>UNIT OPERATING COSTS</b>									
Mining - Includes Power (\$/dmt Mined)	\$106.87	\$108.91	\$98.98	\$84.52	\$97.77	\$102.25	\$98.97	\$91.81	<b>\$97.16</b>
WIN Tech Staff - (\$/dmt Mined)	\$36.02	\$8.49	\$4.76	\$4.48	\$6.50	\$6.96	\$6.75	\$8.09	<b>\$6.71</b>
Milling - Ex Power (\$/dmt Milled)	\$0.00	\$28.96	\$26.01	\$25.16	\$25.08	\$25.27	\$25.22	\$26.29	<b>\$25.81</b>
Surface Infrastructure (\$/dmt Milled)	\$0.00	\$15.62	\$13.97	\$13.73	\$13.73	\$13.73	\$13.69	\$13.21	<b>\$14.07</b>
Administration (\$/dmt Milled)	\$0.00	\$22.15	\$14.20	\$13.55	\$15.07	\$16.10	\$15.19	\$13.92	<b>\$17.27</b>
<b>TOTAL (\$/t Milled)</b>	<b>\$0.00</b>	<b>\$169.06</b>	<b>\$162.37</b>	<b>\$145.83</b>	<b>\$159.92</b>	<b>\$165.96</b>	<b>\$164.41</b>	<b>\$130.83</b>	<b>\$161.01</b>
<b>Average Nickel Cash Cost/lb Ni (US\$/lb)</b>									
Average Nickel Cash Cost/lb Ni (US\$/lb)	\$0.00	\$4.01	\$3.87	\$3.31	\$3.82	\$3.54	\$3.62	\$2.90	<b>\$3.67</b>
<b>Average Nickel Cash Cost/t Ni (AUD\$/t)</b>									
Average Nickel Cash Cost/t Ni (AUD\$/t)	\$0.00	\$8.85	\$4.97	\$4.23	\$5.01	\$4.51	\$4.09	\$3.08	<b>\$5.72</b>
<b>TOTAL UNIT COSTS</b>									
Average Total cost per tonne (Milled)	\$0	\$365	\$206	\$184	\$208	\$209	\$185	\$139	<b>\$247</b>
<b>Average Nickel Total Cost/lb Ni (US\$/lb)</b>									
Average Nickel Total Cost/lb Ni (US\$/lb)	\$0.00	\$8.85	\$4.97	\$4.23	\$5.01	\$4.51	\$4.09	\$3.08	<b>\$5.72</b>
<b>Average Nickel Total Cost/t Ni (AUD\$/t)</b>									
Average Nickel Total Cost/t Ni (AUD\$/t)	\$0	\$30,020	\$16,849	\$14,353	\$16,998	\$15,284	\$13,860	\$10,459	<b>\$19,387</b>

Costs do not include "Past Mine Gate Costs" namely concentrate transport, offtake costs, and royalties.

It should be noted that:

- Total Project Capital Costs are AUS\$433M.
- Pre-Production Capital and Operating Costs are AUS\$257M, up until first concentrate production.

**Table 45 - Concentrate Transport and Offtake Costs**

YEAR	Rate(\$/t)	Year1	Year2	Year3	Year4	Year5	Year6	Year7	Year8	TOTAL
Concentrate Produced (dmt)		0	56,660	87,442	97,263	94,055	104,756	101,112	75,380	<b>616,668</b>
Concentrate Shipped (dmt)		0	50,000	84,500	100,500	94,000	104,500	100,500	82,668	<b>616,668</b>
Moisture (%)		6.0%	6.0%	6.0%	6.0%	6.0%	6.0%	6.0%	6.0%	
Concentrate Shipped (wmt)		0	53,000	89,570	106,530	99,640	110,770	106,530	87,628	<b>653,668</b>
<b>Con Transport Costs</b>										
Haulage to Esperance (AUD\$)	\$36.00	\$0	\$1,908,000	\$3,224,520	\$3,835,080	\$3,587,040	\$3,987,720	\$3,835,080	\$3,154,620	<b>\$23,532,060</b>
Storage Container Loading (AUD\$)	\$5.20	\$0	\$275,600	\$465,764	\$553,956	\$518,128	\$576,004	\$553,956	\$455,667	<b>\$3,399,075</b>
Receiving Agent (AUD\$)	\$7.69	\$0	\$81,538	\$137,800	\$163,892	\$153,292	\$170,415	\$163,892	\$134,813	<b>\$1,005,644</b>
Esperance Port Costs (AUD\$)	\$1.54	\$0	\$407,692	\$689,000	\$819,462	\$766,462	\$852,077	\$819,462	\$674,064	<b>\$5,028,218</b>
Assays (AUD\$)	\$1.85	\$0	\$97,846	\$165,360	\$196,671	\$183,951	\$204,498	\$196,671	\$161,775	<b>\$1,206,772</b>
Overseas Freight (AUD\$)	\$53.85	\$0	\$2,854,050	\$4,823,345	\$5,736,641	\$5,365,614	\$5,964,965	\$5,736,641	\$4,718,786	<b>\$35,200,040</b>
Insurance (AUD\$)	\$4.85	\$0	\$225,245	\$382,063	\$453,324	\$423,108	\$468,529	\$448,883	\$366,456	<b>\$2,767,608</b>
<b>TOTAL TRANSPORT COSTS (\$/wmt)</b>	<b>\$110.97</b>	<b>\$0</b>	<b>\$5,849,972</b>	<b>\$9,887,852</b>	<b>\$11,759,025</b>	<b>\$10,997,594</b>	<b>\$12,224,209</b>	<b>\$11,754,584</b>	<b>\$9,666,182</b>	<b>\$72,139,417</b>
<b>Offtake Penalties (AUS\$)</b>										
Nickel (Ni)	0	\$0	\$0	\$0	\$0	\$0	\$0	\$0	\$0	<b>\$0</b>
Magnesium Oxide (MgO)	\$74.60	\$0	\$3,262,873	\$5,909,362	\$7,598,168	\$8,057,991	\$7,828,156	\$7,930,170	\$5,414,573	<b>\$46,001,292</b>
Arsenic (As)	\$30.79	\$0	\$4,839,854	\$1,969,241	\$3,224,839	\$4,979,280	\$3,057,042	\$919,576	\$0	<b>\$18,989,832</b>
<b>TOTAL PENALTIES (AUS\$/dmt)</b>	<b>\$105.39</b>	<b>\$0</b>	<b>\$8,102,727</b>	<b>\$7,878,603</b>	<b>\$10,823,006</b>	<b>\$13,037,271</b>	<b>\$10,885,198</b>	<b>\$8,849,746</b>	<b>\$5,414,573</b>	<b>\$64,991,124</b>

## Applicable Royalty Costs

**Table 46 - Applicable Royalty Cost Summary**

YEAR	Year 1	Year 2	Year 3	Year 4	Year 5	Year 6	Year 7	Year 8	TOTAL
Concentrate Produced (dmt)	0	56,660	87,442	97,263	94,055	104,756	101,112	75,380	<b>616,668</b>
Concentrate Shipped (dmt)	0	50,000	84,500	100,500	94,000	104,500	100,500	82,668	<b>616,668</b>
<b>ROYALTY COSTS</b>									
Nickel - 2.5% (AUD)	\$0	\$3,380,413	\$5,858,239	\$6,931,203	\$6,410,082	\$7,216,357	\$6,980,646	\$5,788,760	<b>\$42,565,700</b>
Copper - 2.5% (AUD)	\$0	\$0	\$0	\$0	\$0	\$0	\$0	\$0	<b>\$0</b>
Cobalt - 2.5% (AUD)	\$0	\$0	\$23,471	\$0	\$0	\$0	\$0	\$0	<b>\$23,471</b>
Gold - 2.5% (AUD)	\$0	\$0	\$0	\$0	\$0	\$0	\$0	\$0	<b>\$0</b>
Palladium - 2.5% (AUD)	\$0	\$81,793	\$162,922	\$159,713	\$119,914	\$146,804	\$152,011	\$114,150	<b>\$937,308</b>
Platinum - 2.5% (AUD)	\$0	\$0	\$0	\$0	\$0	\$0	\$0	\$0	<b>\$0</b>
Lease Royalty - 2.83% Av (AUD)	\$0	\$3,462,206	\$6,044,632	\$7,090,916	\$6,570,781	\$8,504,546	\$9,596,483	\$8,306,345	<b>\$49,575,909</b>
<b>Total Royalties (\$AUD)</b>	<b>\$0</b>	<b>\$6,924,413</b>	<b>\$12,089,264</b>	<b>\$14,181,831</b>	<b>\$13,100,778</b>	<b>\$15,867,708</b>	<b>\$16,729,139</b>	<b>\$14,209,255</b>	<b>\$93,102,388</b>
Unit Royalty Cost (\$/dmt Concentrate)	\$0	\$138.49	\$143.07	\$141.11	\$139.37	\$151.84	\$166.46	\$171.88	<b>\$150.98</b>

Concentrate Transport and Offtake Costs (Table 45) and the Applicable Royalty Costs (Table 46) are shown in Australian dollars. Combined these costs can be defined as past mine gate costs in terms of operation unit production costs.

Third party royalties (lease royalties) applicable to mining apply at different rates depending on which mining tenement is under consideration. A weighted average mean has been applied over all production at this stage of study.

## Mine Closure Costs

Mine closure will incur significant costs, however with the added additional resources from the other 7 deposits to be considered closure costs may not be incurred for 15 years or more. The discharge pipeline will have to be pulled up and disposed of offsite and the trench back filled, ripped and seeded. ROM pads will have the top gravel surface bulldozed into the open pits to remove any trace of oxidising sulphides, then topsoil replaced and seeded. Portions of the access roads are currently bituminised

and will have to be rehabilitated to a natural surface. Safety bunds will be required to limit access to the open pit sites. The tails dam will also require sealing and covering with acceptable vegetation.

Ongoing periodic monitoring will be required to ensure no adverse colonising weeds establish themselves or erosion channels form. This would be monthly over twelve months by which time the surface should have stabilised.

No allowance has been made for this in the financial model as the sale of capital items has the potential to offset the anticipated closure and rehabilitation costs.

## Project Revenue

The Project Gross Revenue was modelled as per the estimated offtake arrangements and applying the study commodity pricing assumptions. The Net Revenue was calculated as the Gross Revenue minus the past mine gate costs being concentrate transport, offtake costs and applicable royalties.

**Table 47 - Project Revenue Summary**

YEAR	Year 1	Year 2	Year 3	Year 4	Year 5	Year 6	Year 7	Year 8	TOTAL
<b>CONCENTRATE DELIVERED</b>									
Dry Weight (dmt)	0	50,000	84,500	100,500	94,000	104,500	100,500	82,668	<b>616,668</b>
<b>GROSS NSR INCOME</b>									
Nickel (USD)	\$0	\$96,960,000	\$163,862,400	\$194,889,600	\$182,284,800	\$202,646,400	\$194,889,600	\$160,310,249	<b>\$1,195,843,049</b>
Copper (USD)	\$0	\$0	\$0	\$0	\$0	\$0	\$0	\$0	<b>\$0</b>
Cobalt (USD)	\$0	\$0	\$610,251	\$0	\$0	\$0	\$0	\$0	<b>\$610,251</b>
Palladium (USD)	\$0	\$0	\$0	\$0	\$0	\$0	\$0	\$0	<b>\$0</b>
Platinum (USD)	\$0	\$2,126,621	\$4,235,974	\$4,152,527	\$3,117,773	\$3,816,911	\$3,952,288	\$2,967,912	<b>\$24,370,006</b>
<b>Total Gross Revenue (USD)</b>	<b>\$0</b>	<b>\$99,086,621</b>	<b>\$168,708,625</b>	<b>\$199,042,127</b>	<b>\$185,402,573</b>	<b>\$206,463,311</b>	<b>\$198,841,888</b>	<b>\$163,278,161</b>	<b>\$1,220,823,306</b>
<b>PAST MINE GATE COSTS</b>									
Transport & Offtake Costs (AUD)	\$0	\$13,952,699	\$17,766,455	\$22,582,031	\$24,034,865	\$23,109,406	\$20,604,329	\$15,080,754	<b>\$137,130,541</b>
Payable Royalties (AUD)	\$0	\$6,924,413	\$12,089,264	\$14,181,831	\$13,100,778	\$15,867,708	\$16,729,139	\$14,209,255	<b>\$93,102,388</b>
<b>Total Net Revenue (AUD) - CF</b>	<b>\$0</b>	<b>\$131,563,844</b>	<b>\$229,696,011</b>	<b>\$269,454,795</b>	<b>\$248,099,084</b>	<b>\$278,658,749</b>	<b>\$268,577,128</b>	<b>\$221,907,161</b>	<b>\$1,647,956,772</b>



**Project Financial Model Results**

**Table 48 -Project Financial & Cashflow Summary**

ITEM	Year 1	Year 2	Year 3	Year 4	Year 5	Year 6	Year 7	Year 8	TOTAL
<b>MINE ORE PRODUCTION</b>									
Total Ore Tonnes (t)	65,878	418,430	792,540	839,484	813,571	812,116	834,744	470,792	<b>5,047,555</b>
Ore Grade Ni (%)	1.28	1.55	1.48	1.55	1.51	1.67	1.64	1.54	<b>1.56</b>
<b>MILL PRODUCTION</b>									
Ore Milled Tonnes (t)	0	480,000	760,000	800,000	800,000	800,000	800,000	607,556	<b>5,047,556</b>
<b>CONCENTRATE DELIVERIES</b>									
Concentrate Deliveries (dmt)	0	50,000	84,500	100,500	94,000	104,500	100,500	82,668	<b>616,668</b>
Con Grade Ni (%)	0	10.1	10.1	10.1	10.1	10.1	10.1	10.1	<b>10.1</b>
Con Grade Cu (ppm)	0	13,172	13,603	14,454	14,719	13,232	12,166	10,967	<b>13,226</b>
Con Grade Co (ppm)	0	2,759	2,649	2,736	2,919	2,586	2,216	1,843	<b>2,524</b>
Con Grade Au (ppm)	0	0.64	0.62	0.45	0.44	0.54	0.72	0.75	<b>0.59</b>
Con Grade Pd (ppm)	0	1.99	2.19	1.61	1.36	1.54	1.65	1.34	<b>1.64</b>
Con Grade Pt (ppm)	0	0.56	0.54	0.42	0.40	0.44	0.45	0.37	<b>0.45</b>
<b>COST SUMMARY</b>									
Capital	\$181,772,749	\$93,917,002	\$32,857,398	\$30,721,641	\$38,339,853	\$34,809,962	\$16,098,649	\$4,709,800	\$433,227,055
Operating	\$19,788,277	\$81,149,721	\$123,399,580	\$116,660,668	\$127,934,385	\$132,771,133	\$131,529,337	\$79,486,727	\$812,719,828
<b>TOTAL SITE COSTS</b>	<b>\$201,561,027</b>	<b>\$175,066,723</b>	<b>\$156,256,979</b>	<b>\$147,382,309</b>	<b>\$166,274,238</b>	<b>\$167,581,095</b>	<b>\$147,627,986</b>	<b>\$84,196,527</b>	<b>\$1,245,946,884</b>
<b>OPERATING UNIT COSTS</b>									
Mining - Includes Power (\$/dmt Mined)	\$106.87	\$108.91	\$98.98	\$84.52	\$97.77	\$102.25	\$98.97	\$91.81	<b>\$97.16</b>
WIN Tech Staff - (\$/dmt Mined)	\$36.02	\$8.49	\$4.76	\$4.48	\$6.50	\$6.96	\$6.75	\$8.09	<b>\$6.71</b>
Milling - Ex Power (\$/dmt Milled)	\$0.00	\$28.96	\$26.01	\$25.16	\$25.08	\$25.27	\$25.22	\$26.29	<b>\$25.81</b>
Surface Infrastructure (\$/dmt Milled)	\$0.00	\$15.62	\$13.97	\$13.73	\$13.73	\$13.73	\$13.69	\$13.21	<b>\$14.07</b>
Administration (\$/dmt Milled)	\$0.00	\$22.15	\$14.20	\$13.55	\$15.07	\$16.10	\$15.19	\$13.92	<b>\$17.27</b>
<b>TOTAL (\$/t Milled)</b>	<b>\$0.00</b>	<b>\$169.06</b>	<b>\$162.37</b>	<b>\$145.83</b>	<b>\$159.92</b>	<b>\$165.96</b>	<b>\$164.41</b>	<b>\$130.83</b>	<b>\$161.01</b>
Average Nickel Cash Cost/lb Ni (US\$/lb)	\$0.00	\$4.01	\$3.87	\$3.31	\$3.82	\$3.54	\$3.62	\$2.90	<b>\$3.67</b>

# Standalone Mt Edwards Project Scoping Study Highlights Nickel Potential

7 March 2024

<b>TOTAL UNIT COSTS</b>									
Average Total cost per tonne - Milled (AUD/t)	\$0.00	\$364.72	\$205.60	\$184.23	\$207.84	\$209.48	\$184.53	\$138.58	\$246.84
Average Nickel Total Cost/lb Ni (US\$/lb)	\$0.00	\$8.85	\$4.97	\$4.23	\$5.01	\$4.51	\$4.09	\$3.08	\$5.72
<b>REVENUE</b>									
Gross Revenue - NSR (AUD)	\$0.00	\$152,440,955	\$259,551,731	\$306,218,658	\$285,234,727	\$317,635,863	\$305,910,596	\$251,197,171	\$1,878,189,701
<b>Past Mine Gate Costs :</b>									
TRANSPORT & OFFTAKE COSTS (AUD)	\$0	\$13,952,699	\$17,766,455	\$22,582,031	\$24,034,865	\$23,109,406	\$20,604,329	\$15,080,754	\$137,130,541
TOTAL ROYALTY COSTS (AUD)	\$0	\$6,924,413	\$12,089,264	\$14,181,831	\$13,100,778	\$15,867,708	\$16,729,139	\$14,209,255	\$93,102,388
<b>Total Net Revenue (AUD) - For Cashflow</b>	\$0	\$131,563,844	\$229,696,011	\$269,454,795	\$248,099,084	\$278,658,749	\$268,577,128	\$221,907,161	\$1,647,956,772
<b>Cashflow (Pre Tax)</b>	-\$201,561,027	-\$43,502,880	\$73,439,032	\$122,072,486	\$81,824,846	\$111,077,653	\$120,949,141	\$137,710,634	\$402,009,886
<b>Cumm Cashflow (Pre Tax)</b>	-\$201,561,027	-\$245,063,906	-\$171,624,874	-\$49,552,388	\$32,272,458	\$143,350,111	\$264,299,252	\$402,009,886	

The following table demonstrates the Project economics from US\$16,000/t Ni to US\$32,000/t Ni, which reflects the high and low levels of the Nickel price during 2023.

**Table 49 - Financial Model Results and Nickel Price Sensitivity**

Nickel Price	USD/t	16k/t	20k/t	24k/t	28k/t	32k/t
	US\$/lb	7.26	9.07	10.89	12.70	14.51
(AUD:US = 0.65)	AUD/t	24.6k/t	30.8k/t	36.9k/t	43.1k/t	49.2k/t
<b>Total Project Term</b>	<b>Month</b>	94	94	94	94	94
<b>First Revenue</b>	<b>Month</b>	17	17	17	17	17
<b>Pay Back Period (Start)</b>	<b>Month</b>	N/A	81	53	43	37
<b>Pay Back Period (From Mill Completion)</b>	<b>Month</b>	N/A	65	37	27	21
<b>Max Negative Cashflow Month</b>	<b>Month</b>	34	18	16	16	16
<b>Maximum Negative Cash Flow</b>	<b>AUD\$</b>	-\$302.9M	-\$272.8M	-\$269.2M	-\$269.2M	-\$269.2M
<b>Total Free Cash Flow (Pre Tax)</b>	<b>AUD\$</b>	-\$177.7M	\$112.2M	\$402.3M	\$691.8M	\$981.7M
<b>Discounted CF 8% - NPV8 (Pre Tax)</b>	<b>AUD\$</b>	-\$204.7M	-\$3.7M	\$197.4M	\$398.4M	\$599.5M
<b>Internal Rate of Return (Pre Tax)</b>	<b>%</b>	N/A	7.7	22.9	34.6	44.2

**Table 50 – NPV Sensitivity Analysis**

		-10%		BASELINE	10%	
SENSITIVITY	Unit	NPV8	Change	NPV8	Change	NPV8
Nickel Price	AUD\$	\$76.7M	-\$120.7M	\$197.4M	\$120.7M	\$318.1M
Nickel Grade	AUD\$	\$76.7M	-\$120.7M	\$197.4M	\$120.7M	\$318.1M
Exchange Rate	AUD\$	\$90.5M	-\$106.9M	\$197.4M	\$130.6M	\$328.0M
Total Operating Costs	AUD\$	\$133.2M	-\$64.2M	\$197.4M	\$57.5M	\$254.9M
Pre Production Capital	AUD\$	\$173.0M	-\$24.4M	\$197.4M	\$24.4M	\$221.8M
Sustaining Capital	AUD\$	\$181.9M	-\$15.5M	\$197.4M	\$15.5M	\$212.9M
		NPV8.8	Change	NPV8	Change	NPV7.2
Discount Rate	AUD\$	\$181.8M	-\$15.6M	\$197.4M	\$16.3M	\$213.7M

Table 50 demonstrates the effect of varying cost and revenue assumptions on the underlying viability of the Project.

**Potential Sources of Funding**

The Scoping Study has been completed to a level of accuracy of +/-40% as is applicable in accordance with scoping level accuracy. To achieve the range of outcomes indicated in the Scoping Study, funding in the order of \$270 million is required. It is possible or likely (as the case may be) that the required funding may only be available on terms that may be dilutive to or otherwise affect the value of the Widgie’s existing shares.

Further feasibility studies are required, before any development decisions would be made, to refine the accuracy of the projections and costs before any development funding would be sought. On completion of a full feasibility Study and a positive outcome Widgie will be positioned to source traditional financing through debt and equity markets. It is also possible that Widgie could pursue other ‘value realisation’ strategies such as a sale, partial sale, or joint venture of the Project.

In February 2024 the Australian Government added Nickel to the Critical Minerals list opening up other potential funding avenues for the Company and Project. As part of this change in classification

companies are able to access financing under the governments \$4B Critical Minerals Facility. This is a significant and very new opportunity not generally open to mining Projects.

The government recognises the importance of the nickel mining industry and the strategic role it plays in decarbonisation and development of Australia's battery metals manufacturing aspirations.

Widgie is now ideally placed to harness this opportunity in tandem with JV and equity opportunities introducing strong and capable partners to the Project.

## Recommendations and areas of opportunity

### Mine life extensions and Resource Growth

This Scoping Study presents a preliminary analysis of the Project potential for a future viable Tier 1 nickel sulphide Project at Mt Edwards. The considered Production Target of 5.05mt@ 1.56% is comprised of 77% Indicated material.

Mineralisation is considered to remain open at all Resources, other than Armstrong, further drilling may lead to increased Resources and potential for extended mine life.

There are an additional seven identified nickel Mineral Resources located close to the planned operation that currently have a combined resource of 5.37Mt @ 1.44% Ni. These offer an excellent opportunity to provide additional mill feed and mine life to the operation.

It is recommended that once further new Resource estimates are available that an updated mine plan and schedule be completed and the Project model updated. This would include the additional material from the five Mineral Resources considered herein along with the remaining seven Inferred Resources not considered within this Scoping Study.

### Mining costs

Mining costs represent a significant proportion of overall costs. Confirmation of assumed costs by carrying out a competitive tender process with mining contractors is warranted to determine/confirm if there is any benefit in considering that as an alternative operating model.

### Metallurgical testwork and process improvements

Further additional metallurgical testwork will continue with new results expected. Testwork has indicated potential further improvements to enhance concentrate quality and grades and commensurate with this to reduce penalty elements. Work on preconcentration does present an opportunity to realise higher payability in precious metals than is otherwise the case in nickel concentrates. Equally work carried out on liberation of an iron rich nickel tailings stream will be examined further to potentially liberate more nickel (and iron) thus greater value from the ore.

### Capital and operating costs

Capital costs are significant reflecting an ongoing trend for new Resource projects in Australia. Opportunities exist to consider suitable dormant processing plants and other infrastructure items both within and outside of Australia. This may lead to reduced capital costs of the Project.

Capital intensity can further be reduced by considering opportunities to expand annual throughput, achieving economies of scale by incorporating feed from other currently dormant nickel projects in the region. Expanding output and/or mine life will reduce amortisation rates and reduce ongoing operating costs making the Project a potentially more robust proposition.

The opportunity exists for in-pit tails storage disposal thereby reducing capital requirements and operating costs.

## Products, payability and offtake

Improvements in payability may be achieved upon establishing exact concentrate grade specifications and ensuring a competitive product sale process is undertaken. This may include securing local offtake partners (minimising offsite transport costs) or offtakers willing to pay higher premiums for by-products. The opportunity for reducing offtake penalties for diluents by blending is evident.

Attracting a premium for low carbon intensity and/or ethically sourced nickel products may further improve the economics of the Project.

Through offtake negotiations the option to supply concentrate at reduced grades maybe considered which will allow for higher recovery rates in the concentrator.

## Permitting and approvals

Permitting processes should now commence and a basic permitting framework for the Project established. This should be considered a high priority given the delays currently seen on other Projects in the West Australian mining industry.

## Downstream processing

Opportunities for greater value realisation by considering further downstream processing of nickel concentrates represents an opportunity to be considered given the unique longer life of the Project.

Consideration of downstream processing in close proximity to the concentrator has the capacity of reducing offsite transport costs, mitigating penalties (traditionally incurred from smelting processes) and increasing payability by virtue of selling a more refined product. Improving overall viability will be a significant focal point for future studies.

## Competent Person Statement – Exploration Results

*The information in this announcement that relates to exploration results and sampling techniques is based on and fairly represents information and supporting documentation compiled by Mr William Stewart, who is a full-time employee of Widgie Nickel Limited. Mr Stewart is a member of the Australian Institute of Metallurgy and Mining (member no 224335) and Australian Institute of Geoscientists (member no 4982). Mr Stewart has sufficient experience that is relevant to the style of mineralisation and type of deposit under consideration and to the activity being undertaken to qualify as a Competent Person as defined in the 2012 Edition of the ‘Australasian Code for Reporting of Exploration Results, Mineral Resources and Ore Reserves’. Mr Stewart consents to the inclusion in the report of the matters based on his information in the form and context in which it appears.*

## Competent Person Statement – Metallurgical Results

*The information in this announcement that relates to Metallurgical Results is based on information compiled by independent consulting metallurgist Brian McNab (FAusIMM, (CP). B.Sc Extractive Metallurgy). Mr McNab is a Member of AusIMM. He is employed by Wood Mining and Metals. Mr McNab has sufficient experience which is relevant to the style of mineralisation and type of deposit under consideration and to the activity, which is undertaken, to qualify as a Competent Person as defined in the JORC 2012 Australasian Code for Reporting of Exploration Results, Mineral Resources and Ore Reserves. Mr McNab consents to the inclusion in the announcement of the matters based on the information made available to him, in the form and context in which it appears.*

## Competent Person Statement – Mining

*The information in this announcement that relates to Mining and Financial Analysis based on information compiled by independent consulting Mining Engineer Mr Simon Krebs (FAusIMM, B.Eng (WASM)Mining). Mr Krebs is a Member of AusIMM. He is self-employed by RCI Mining and Project Development Services. Mr Krebs has sufficient experience which is relevant to the style of mineralisation and type of deposit under consideration and to the activity, which is undertaken, to qualify as a Competent Person as defined in the JORC 2012 Australasian Code for Reporting of Exploration Results, Mineral Resources and Ore Reserves. Mr Krebs consents to the inclusion in the announcement of the matters based on the information made available to him, in the form and context in which it appears.*

## Forward Looking Statements

*This announcement includes forward-looking statements that are only predictions and are subject to known and unknown risks, uncertainties, assumptions and other important factors, many of which are beyond the control of Widgie Nickel Limited, the directors and the Company's management. Such forward-looking statements are not guarantees of future performance.*

*Examples of forward-looking statements used in this announcement include use of the words 'may', 'could', 'believes', 'estimates', 'targets', 'expects', or 'intend' and other similar words that involve risks and uncertainties. These statements are based on an assessment of present economic and operating conditions, and on a number of assumptions regarding future events and actions that, as at the date of announcement, are expected to take place.*

*Actual values, results, interpretations or events may be materially different to those expressed or implied in this announcement. Given these uncertainties, recipients are cautioned not to place reliance on forward-looking statements in the announcement as they speak only at the date of issue of this announcement. Subject to any continuing obligations under applicable law and the ASX Listing Rules, Widgie Nickel Limited does not undertake any obligation to update or revise any information or any of the forward-looking statements in this announcement or any changes in events, conditions or circumstances on which any such forward-looking statement is based.*

*This announcement has been prepared by Widgie Nickel Limited. The document contains background information about Widgie Nickel Limited current at the date of this announcement. The announcement is in summary form and does not purport to be all inclusive or complete. Recipients should conduct their own investigations and perform their own analysis in order to satisfy themselves as to the accuracy and completeness of the information, statements and opinions contained in this announcement.*

*The announcement is for information purposes only. Neither this announcement nor the information contained in it constitutes an offer, invitation, solicitation or recommendation in relation to the purchase or sale of shares in any jurisdiction. The announcement may not be distributed in any jurisdiction except in accordance with the legal requirements applicable in such jurisdiction. Recipients should inform themselves of the restrictions that apply to their own jurisdiction as a failure to do so may result in a violation of securities laws in such jurisdiction.*

*This announcement does not constitute investment advice and has been prepared without taking into account the recipient's investment objectives, financial circumstances or particular needs and the opinions and recommendations in this announcement are not intended to represent recommendations of particular investments to particular persons.*

*Recipients should seek professional advice when deciding if an investment is appropriate. All securities transactions involve risks, which include (among others) the risk of adverse or unanticipated market, financial or political developments. To the fullest extent of the law, Widgie Nickel Limited, its officers, employees, agents and advisers do not make any representation or warranty, express or implied, as to the currency, accuracy, reliability or completeness of any information, statements, opinion, estimates, forecasts or other representations contained in this announcement. No responsibility for any errors or omissions from the announcement arising out of negligence or otherwise is accepted.*



## Compliance Statement

The information in this report that relates to Exploration Results and MREs are extracted from the ASX Announcements listed in the table below, which are also available on the Company’s website [www.widgienickel.com.au](http://www.widgienickel.com.au).

Date	Title
29 January 2024	Widgie Townsite Mineral Resource Update (ASX:WIN)
15 January 2024	Widgie 3 Mineral Resource Update (ASX:WIN)
9 January 2024	Substantial Uplift to Gillett Mineral Resource (ASX:WIN)
13 December 2023	Armstrong Mineral Resource Update (ASX:WIN)
6 October 2020	132 Nickel Mineral Resource and Exploration Update at Mt Edwards (ASX:NMT)

The Company confirms that it is not aware of any new information or data that materially affects the information included in the original market announcements and that all material assumptions and technical parameters underpinning the estimates in the market announcements continue to apply and have not materially changed. The Company confirms that the form and context in which the Competent Persons’ findings are presented have not been materially modified from the original market announcements.

**Approved by: Board of Widgie Nickel Ltd**

-ENDS-

<p><b>For further details please contact:</b></p> <p>Steve Norregaard Managing Director <a href="mailto:steve@widgienickel.com.au">steve@widgienickel.com.au</a> 0472 621 529</p>	<p><b>Media Enquiries</b></p> <p>Fiona Marshall White Noise Communications <a href="mailto:fiona@whitenoisecomms.com">fiona@whitenoisecomms.com</a> 0400 512 109</p>
---	--

## About Widgie Nickel

Widgie Nickel (ASX:WIN) is a mineral exploration company holding 240km<sup>2</sup> of granted mining tenure across the highly prolific Widgiemooltha Dome with exposure to the critical metals nickel and lithium.

The Company is developing its Mount Edwards Nickel Project which is a unique collection of twelve (12) deposits with a total Mineral Resource Estimate of 13.164 Mt @ 1.45% Ni for 190,300t. Five of the deposits are subject of a Scoping Study contemplating development of a standalone nickel concentrator at Mt Edwards.

Widgie also holds the Faraday-Trainline Lithium Project, a shovel ready Project with a Mineral Resource Estimate of 1.96 Mt at 0.69% Li<sub>2</sub>O\*. The deposit shows substantial expansion potential with mineralisation open at depth with potential for repeat stacked pegmatites.

The Company's tenure is located just 80km south of the major regional centre of Kalgoorlie in Western Australia, 30km south-west of Kambalda.

\*The information that relates to the JORC Mineral Resource Estimates for Mount Edwards Nickel Project and Faraday-Trainline Lithium Deposit is extracted from the Company's ASX Announcements: 29 January 2024 and 8 November 2023 which are available to view on the Company's website: [www.widgienickel.com.au](http://www.widgienickel.com.au)

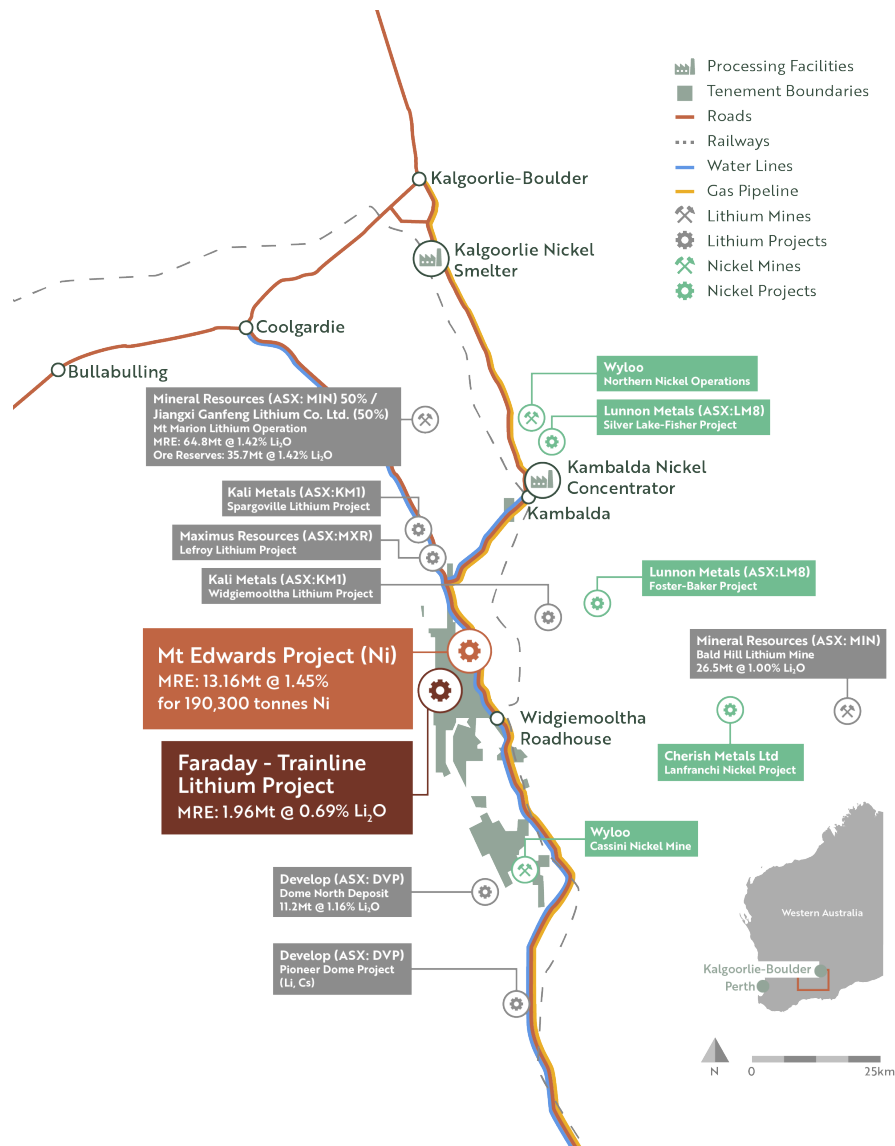

Widgie Nickel Project Map